

WIND

WIND-ECM

Centrifugal fan coil unit



Product Catalog

Rel. 02_02_02_03C_EN

WIND WIND-ECM

Centrifugal fan coil unit

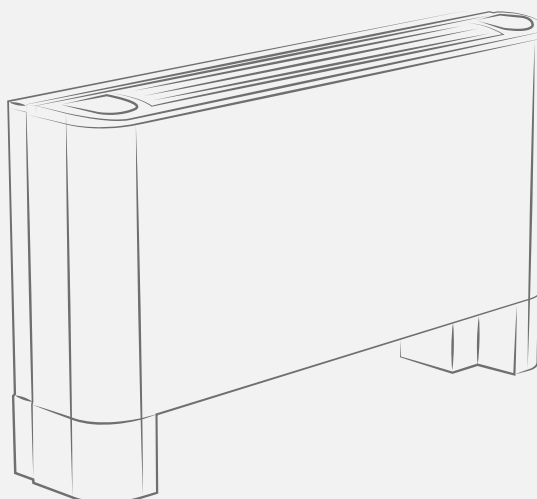

A GROUP S.p.A (Trademark EDEN)
participates in the ECP programme for FCU.
Check ongoing validity of certificate:
www.eurovent-certification.com

Uncompromising style and performance

 **0.6 ÷ 11.6** kW
cooling

 **0.7 ÷ 12.9** kW
heating

 **50%**
energy saving up to 50%

 **123 - 2449** m³/h
air flow



Exclusive comfort
with ultimate style, elegance
and maximum functionality.





Construction features



Structure:

in Z200 hot-dip galvanized steel sheet with a thickness of 0.8 mm and 1 mm (sizes 100 ÷ 120) insulated with closed cell polyolefin-based insulation. Condensate drain pan in hot-dip galvanized Z140 pre-painted 0.8 mm thick with closed cell polyolefin-based insulation 3 mm thick complete with connection for condensate drain external Ø 20 mm



Decorative cabinet:

in hot-dip galvanized steel sheet and pre-coated with a polyvinyl chloride film to guarantee high resistance to corrosion, pure white RAL 9010. The grilles for air diffusion and the flaps are instead made of injection-molded ABS, light gray RAL 7035 color. Other colors or special finishes available on request.



Filter:

of standard supplied regenerable filter with galvanized steel frame and polypropylene filter fabric with efficiency class G1 * / EU1 **.

Alternatively, a wide range of filters with greater efficiencies are available, including G2 * / EU2 ** and G3 * / EU3 **. (* according to EN779 / ** according to Eurovent)



Fan section:

consisting of double intake centrifugal fans, with impellers in aluminum, or ABS statically and dynamically balanced, directly fitted onto the motor shaft. Single-phase asynchronous electric motor with overload protection, 6 rotation speeds (3 of which are connected).

The motor is directly coupled to the fans, and cushioned with elastic supports for the benefit of low noise. The series can also be equipped with innovative Brushless ECM motors, high head motors or motors with fail contact.



Coils:

in copper tube with aluminum fins with continuous pack blocked on the tubes by mechanical expansion. Brass manifolds equipped with Ø 1/2 "and 3/4" female gas connections and easily accessible air vent valves. Hydraulic connections positioned on the left (front view), on request supplied on the right. The coils are reversible, so the connection side can also be reversed on site. The heat exchange coil is not suitable for use in corrosive atmospheres.



Customization:

our engineering is able to satisfy any customization requirement, ranging from simple aesthetic finishes to the satisfaction of specific dimensional, performance or application constraints.

☰ Versions

X0

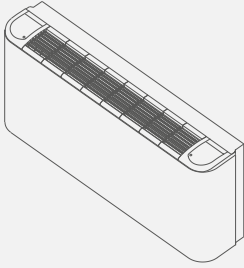

Frontal cabinet version
Vertical installation
Bottom air intake

X9

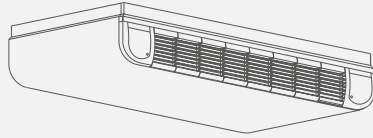

Frontal cabinet version
Horizontal installation
Rear air intake

X2

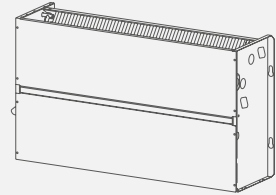

Concealed version
Vertical installation
Vertical air supply

X8

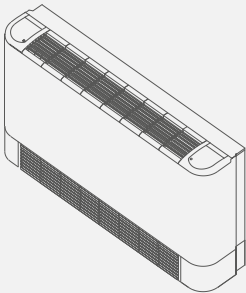

Frontal cabinet version
Vertical installation
Frontal air intake with socle

X1

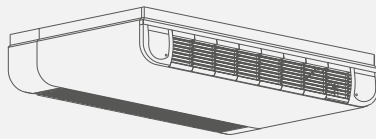

Frontal cabinet version
Horizontal installation
Frontal air intake with socle

X7

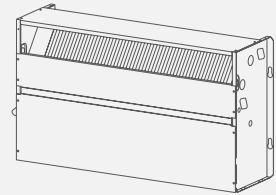

Concealed version
Vertical installation
Frontal air supply

X5

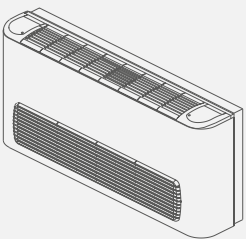

Frontal cabinet version
Vertical installation
Frontal air intake

X4

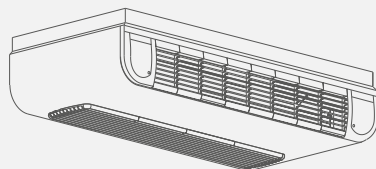

Frontal cabinet version
Horizontal installation
Frontal air intake

X3

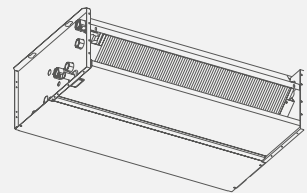

Concealed version
Horizontal installation
Horizontal air supply

| 2 tubi - pipes - tubes Leiter - tubos | | 3R scambiatore - coil - batterie Wärmetauscher - batería | | 10 | 20 | 30 | 40 | 50 | 60 | 70 | 80 | 90 | 100 | 110 | 120 |
|--|---|--|-------------|-------------|-------------|-------------|-------------|-------------|-------------|-------------|-------------|-------------|--------------|--------------|-----|
| 7/12 °C 27 °C d.b. 19 °C w.b. | (E) | Potenza frigorifera totale Total cooling capacity Puissance frigorifique totale Kälteleistung gesamt Potencia frigorífica total | W 6 | 893 | 1685 | 2599 | 2769 | 3826 | 4236 | 4912 | 6034 | 6114 | 8312 | - | - |
| | | W 5 | 830 | 1358 | 2340 | 2340 | 3418 | 3450 | 4024 | 5685 | 5905 | 7892 | 10999 | 11649 | |
| | | W 4 | 767 | 1248 | 2127 | 2127 | 3051 | 3071 | 3451 | 5466 | 5706 | 7633 | 9690 | 10150 | |
| | | W 3 | 713 | 1143 | 1864 | 1895 | 2742 | 3022 | 3030 | 4949 | 5269 | 7014 | 8694 | 9558 | |
| | | W 2 | 654 | 1058 | 1424 | 1424 | 2433 | 2460 | 2810 | 4117 | 4407 | 6383 | 7070 | 7570 | |
| | | W 1 | 617 | 992 | 1282 | 1292 | 2167 | 2397 | 2427 | 3019 | 3214 | 5832 | 6374 | 7154 | |
| | (E) | Potenza frigorifera sensibile Sensible cooling capacity Puissance frigorifique sensible Sensible Kälteleistung Potencia frigorífica total sensible | W 6 | 813 | 1335 | 2129 | 2389 | 2726 | 3416 | 3592 | 4304 | 4224 | 6362 | - | - |
| | | W 5 | 710 | 1128 | 1890 | 1890 | 2408 | 2740 | 3074 | 4005 | 4054 | 5975 | 8509 | 8839 | |
| | | W 4 | 627 | 988 | 1617 | 1697 | 2121 | 2331 | 2611 | 3866 | 3926 | 5713 | 7390 | 7590 | |
| | | W 3 | 563 | 873 | 1444 | 1505 | 1882 | 2372 | 2250 | 3449 | 3569 | 5224 | 6735 | 7215 | |
| | | W 2 | 494 | 788 | 1104 | 1144 | 1683 | 1900 | 1950 | 2827 | 2987 | 4713 | 5390 | 5615 | |
| | | W 1 | 467 | 722 | 1032 | 1122 | 1467 | 1857 | 2059 | 2139 | 4302 | 4804 | 5314 | | |
| 20 °C | (E) | Portata acqua Water flow Débit d'eau Wassermenge Flujo de agua | l/h 6 | 159 | 299 | 457 | 487 | 673 | 743 | 860 | 1065 | 1087 | 1454 | - | - |
| | | l/h 5 | 148 | 240 | 411 | 410 | 600 | 606 | 703 | 1002 | 1040 | 1380 | 1931 | 2041 | |
| | | l/h 4 | 135 | 219 | 363 | 372 | 534 | 538 | 602 | 963 | 1004 | 1333 | 1702 | 1781 | |
| | | l/h 3 | 125 | 202 | 326 | 332 | 479 | 527 | 531 | 871 | 925 | 1226 | 1529 | 1676 | |
| | | l/h 2 | 115 | 186 | 249 | 249 | 425 | 429 | 489 | 727 | 776 | 1117 | 1244 | 1330 | |
| | | l/h 1 | 109 | 173 | 223 | 224 | 377 | 417 | 423 | 534 | 569 | 1019 | 1119 | 1252 | |
| | (E) | Perdite di carico lato acqua Water pressure drop Pertes charge côté eau Wasserseitiger Druckverlust Caídas de presión lado agua | kPa 6 | 1,0 | 3,9 | 10,5 | 11,7 | 25,2 | 30,0 | 58,8 | 34,0 | 16,4 | 27,7 | - | - |
| | | kPa 5 | 0,9 | 2,3 | 7,5 | 8,8 | 19,8 | 25,9 | 37,6 | 30,3 | 15,0 | 27,0 | 26,5 | 33,0 | |
| | | kPa 4 | 0,8 | 2,0 | 6,3 | 7,3 | 16,2 | 17,0 | 27,7 | 28,1 | 13,1 | 23,8 | 21,2 | 25,7 | |
| | | kPa 3 | 0,7 | 1,7 | 5,0 | 5,6 | 13,0 | 16,3 | 21,4 | 23,0 | 12,0 | 22,0 | 17,5 | 23,0 | |
| | | kPa 2 | 0,6 | 1,4 | 2,7 | 3,2 | 10,8 | 12,9 | 18,4 | 16,5 | 9,0 | 19,0 | 12,1 | 15,0 | |
| | | kPa 1 | 0,5 | 1,4 | 2,6 | 3,0 | 8,1 | 10,8 | 16,9 | 8,9 | 5,0 | 14,8 | 10,0 | 13,6 | |
| 45/40 °C 20 °C | (E) | Potenza termica Heating capacity Puissance thermique Heizleistung Energía térmica | W 6 | 1290 | 2160 | 2700 | 3120 | 3950 | 4290 | 5040 | 6270 | 6230 | 9100 | - | - |
| | | W 5 | 1090 | 1910 | 2430 | 2770 | 3500 | 3760 | 4300 | 5900 | 5880 | 8360 | 12280 | 12910 | |
| | | W 4 | 950 | 1610 | 2150 | 2510 | 3050 | 3310 | 3640 | 5660 | 5750 | 8290 | 10690 | 11100 | |
| | | W 3 | 850 | 1410 | 1940 | 2185 | 2720 | 2970 | 3170 | 5040 | 5210 | 7510 | 9510 | 9750 | |
| | | W 2 | 720 | 1250 | 1580 | 1800 | 2440 | 2610 | 2680 | 4180 | 4390 | 6810 | 7585 | 7700 | |
| | | W 1 | 680 | 1150 | 1410 | 1570 | 2130 | 2330 | 2310 | 3080 | 3180 | 6310 | 7070 | 6990 | |
| | (E) | Portata acqua Water flow Débit d'eau Wassermenge Flujo de agua | l/h 6 | 225 | 377 | 470 | 544 | 689 | 747 | 878 | 1093 | 1085 | 1585 | - | - |
| | | l/h 5 | 191 | 333 | 423 | 483 | 609 | 655 | 749 | 1027 | 1024 | 1456 | 2139 | 2249 | |
| | | l/h 4 | 166 | 280 | 374 | 437 | 531 | 576 | 635 | 987 | 1002 | 1443 | 1863 | 1935 | |
| | | l/h 3 | 148 | 246 | 339 | 383 | 474 | 517 | 552 | 887 | 908 | 1308 | 1657 | 1697 | |
| | | l/h 2 | 125 | 218 | 276 | 314 | 426 | 455 | 466 | 728 | 765 | 1187 | 1373 | 1342 | |
| | | l/h 1 | 119 | 201 | 245 | 274 | 371 | 405 | 402 | 536 | 555 | 1099 | 1231 | 1216 | |
| 50 °C 20 °C | (E) | Perdite di carico lato acqua Water pressure drop Pertes charge côté eau Wasserseitiger Druckverlust Caídas de presión lado agua | kPa 6 | 1,4 | 4,9 | 9,1 | 11,8 | 21,6 | 32,4 | 50,2 | 30,4 | 16,2 | 30,6 | - | - |
| | | kPa 5 | 1,1 | 2,8 | 7,6 | 9,2 | 17,4 | 21,8 | 38,0 | 27,1 | 14,5 | 26,0 | 26,6 | 33,5 | |
| | | kPa 4 | 0,8 | 2,4 | 6,1 | 8,0 | 13,7 | 15,8 | 28,4 | 25,1 | 14,0 | 24,0 | 20,8 | 25,5 | |
| | | kPa 3 | 0,7 | 1,7 | 4,2 | 6,1 | 11,2 | 13,1 | 21,0 | 20,0 | 11,0 | 22,0 | 16,9 | 20,1 | |
| | | kPa 2 | 0,5 | 1,4 | 3,0 | 4,3 | 9,3 | 11,3 | 15,6 | 13,9 | 8,1 | 18,0 | 12,1 | 13,0 | |
| | | kPa 1 | 0,5 | 1,2 | 2,9 | 3,5 | 7,3 | 8,5 | 12,7 | 7,7 | 4,0 | 13,9 | 10,0 | 11,0 | |
| | (E) | Potenza termica Heating capacity Puissance thermique Heizleistung Energía térmica | W 6 | 1440 | 2510 | 3230 | 3700 | 4740 | 5150 | 6040 | 7510 | 7480 | 10820 | - | - |
| | | W 5 | 1250 | 2190 | 2910 | 3270 | 4190 | 4480 | 5130 | 7060 | 7070 | 9980 | 14570 | 15330 | |
| | | W 4 | 1100 | 1870 | 2570 | 2950 | 3660 | 3940 | 4360 | 6780 | 6900 | 9870 | 12710 | 13220 | |
| | | W 3 | 990 | 1650 | 2330 | 2600 | 3270 | 3570 | 3800 | 6030 | 6270 | 8960 | 11320 | 11690 | |
| | | W 2 | 850 | 1470 | 1880 | 2110 | 2930 | 3120 | 3220 | 5020 | 5280 | 8130 | 9370 | 9240 | |
| | | W 1 | 810 | 1360 | 1670 | 1850 | 2560 | 2800 | 2780 | 3690 | 3830 | 7520 | 8400 | 8680 | |
| (E) | Portata acqua Water flow Débit d'eau Wassermenge Flujo de agua | l/h 6 | 159 | 299 | 457 | 487 | 673 | 743 | 860 | 1065 | 1087 | 1454 | - | - | |
| | l/h 5 | 148 | 240 | 411 | 410 | 600 | 606 | 703 | 1002 | 1040 | 1380 | 1931 | 2041 | | |
| | l/h 4 | 135 | 219 | 363 | 372 | 534 | 538 | 602 | 963 | 1004 | 1333 | 1702 | 1781 | | |
| | l/h 3 | 125 | 202 | 326 | 332 | 479 | 527 | 531 | 871 | 925 | 1226 | 1529 | 1676 | | |
| | l/h 2 | 115 | 186 | 249 | 249 | 425 | 429 | 489 | 727 | 776 | 1117 | 1244 | 1330 | | |
| | l/h 1 | 109 | 173 | 223 | 224 | 377 | 417 | 423 | 534 | 569 | 1019 | 1119 | 1252 | | |
| 20 °C | (E) | Perdite di carico lato acqua Water pressure drop Pertes charge côté eau Wasserseitiger Druckverlust Caídas de presión lado agua | kPa 6 | 0,8 | 3,2 | 8,5 | 9,5 | 20,2 | 31,5 | 47,2 | 28,7 | 15,9 | 25,6 | - | - |
| | | kPa 5 | 0,7 | 1,6 | 7,0 | 6,7 | 16,5 | 18,5 | 33,1 | 25,5 | 14,7 | 23,1 | 21,7 | 27,5 | |
| | | kPa 4 | 0,6 | 1,5 | 5,6 | 5,9 | 13,5 | 13,6 | 25,2 | 23,7 | 13,8 | 20,4 | 17,3 | 21,5 | |
| | | kPa 3 | 0,5 | 1,2 | 3,8 | 4,6 | 11,1 | 13,1 | 19,1 | 19,6 | 11,1 | 19,1 | 14,3 | 19,3 | |
| | | kPa 2 | 0,4 | 1,0 | 2,4 | 2,8 | 9,0 | 9,9 | 16,5 | 13,7 | 8,1 | 15,8 | 9,9 | 12,5 | |
| | | kPa 1 | 0,4 | 0,9 | 2,4 | 2,4 | 7,3 | 8,7 | 13,6 | 7,5 | 4,1 | 11,9 | 8,2 | 11,4 | |
| | (E) | Portata aria Air flow Débit d'air Luftstrom Flujo de aire | m³/h 6 | 276 | 411 | 531 | 528 | 812 | 813 | 867 | 1231 | 1104 | 1483 | - | - |
| | | m³/h 5 | 227 | 348 | 459 | 451 | 682 | 685 | 708 | 1126 | 1037 | 1373 | 2308 | 2449 | |
| | | m³/h 4 | 190 | 289 | 390 | 395 | 576 | 579 | 578 | 1064 | 989 | 1307 | 1912 | 2004 | |
| | | m³/h 3 | 160 | 244 | 343 | 346 | 495 | 500 | 489 | 925 | 885 | 1106 | 1698 | 1690 | |
| | | m³/h 2 | 136 | 210 | 271 | 263 | 420 | 429 | 413 | 726 | 705 | 1025 | 1266 | 1229 | |
| | | m³/h 1 | 123 | 185 | 227 | 224 | 360 | 368 | 357 | 495 | 485 | 906 | 1095 | 1132 | |
| (E) | Livello di potenza sonora Sound power level Niveau de puissance sonore Schall-Leistungspegel Nivel de potencia acústica | dB(A) 6 | 51 | 53 | 51 | 51 | 56 | 57 | 57 | 68 | 68 | 61 | - | - | |
| | dB(A) 5 | 46 | 49 | 47 | 47 | 51 | 52 | 52 | 68 | 68 | 59 | 69 | 69 | | |
| | dB(A) 4 | 43 | 45 | 44 | 44 | 47 | 47 | 46 | 66 | 66 | 58 | 66 | 66 | | |
| | dB(A) 3 | 37 | 41 | 41 | 40 | 43 | 42 | 42 | 64 | 64 | 56 | 63 | 63 | | |
| | dB(A) 2 | 35 | 39 | 34 | 33 | 39 | 38 | 38 | 59 | 59 | 54 | 58 | 58 | | |
| | dB(A) 1 | 32 | 32 | 30 | 30 | 37 | 34 | 35 | 52 | 52 | 52 | 55 | 55 | | |
| (E) | Livello di pressione sonora Sound pressure level Niveau de pression sonore Schall-Druckpegel Nivel de presión sonora | dB(A) 6 | 42 | 44 | 42 | 42 | 47 | 48 | 48 | 59 | 59 | 52 | - | - | |
| | dB(A) 5 | 37 | 40 | 38 | 38 | 42 | 43 | 43 | 59 | 59 | 50 | 60 | 60 | | |
| | dB(A) 4 | 32 | 36 | 35 | 35 | 38 | 38 | 37 | 57 | 57 | 49 | 57 | 57 | | |
| | dB(A) 3 | 28 | 32 | 32 | 31 | 34 | 33 | 33 | 55 | 55 | 47 | 54 | 54 | | |
| | dB(A) 2 | 24 | 30 | 25 | 24 | 30 | 29 | 29 | 50 | 50 | 45 | 49 | 49 | | |
| | dB(A) 1 | 23 | 23 | 21 | 21 | 28 | 25 | 26 | 43 | 43 | 43 | 46 | 46 | | |

- **Unità standard a bocca libera:** pressione statica esterna = 0 Pa / Il test per la rilevazione del livello di potenza sonora è stato eseguito in accordo con la **normativa EN 16583:2015 / Livello di pressione sonora:** considerata 8,6 dB(A) inferiore rispetto alla potenza sonora in una stanza di 90 m³ con un tempo di riverbero di 0,5 sec. / **Valori tensione ammissibile:** ~230V / 1ph / 50-60Hz
 - **Standard unit with free outlet:** external static pressure = 0 Pa / The sound power level test has been performed according to **EN 16583:2015 standard / Sound pressure level:** 8,6 dB(A) lower that the sound power level for a room of 90 m³ with a reverberation time of 0,5 sec. / **Supported power supply:** ~230V / 1ph / 50-60Hz
 - **Unité standard avec sortie libre:** pression statique externe = 0 Pa / Le test de détection du niveau de puissance acoustique a été réalisé conformément à la norme **EN 16583: 2015 / Niveau de pression sonore:** considéré de 8,6 dB(A) plus

| 4 tubi - pipes - tubes (3+1)R scambiatore - coil - batterie Leiter - tubos (3+1)R Wärmetauscher - batería | | 10 | 20 | 30 | 40 | 50 | 60 | 70 | 80 | 90 | 100 | 110 | 120 | |
|---|--|------------|-------------|-------------|-------------|-------------|-------------|-------------|-------------|-------------|-------------|-------------|-------------|--------------|
| 7/12 °C 27 °C d.b. 19 °C w.b. | Potenza frigorifera totale Total cooling capacity Puissance frigorifique totale Kälteleistung gesamt Potencia frigorífica total | (E) W 6 | 873 | 1565 | 2499 | 2619 | 3646 | 3653 | 4723 | 5654 | 5724 | 8002 | - | - |
| | | (E) W 5 | 810 | 1308 | 2250 | 2330 | 3258 | 3260 | 4070 | 5365 | 5545 | 7552 | 10019 | 11150 |
| | | (E) W 4 | 747 | 1198 | 2037 | 2107 | 2691 | 2890 | 3500 | 5176 | 5366 | 7303 | 8830 | 9760 |
| | | (E) W 3 | 693 | 1103 | 1810 | 1865 | 2432 | 2602 | 3060 | 4709 | 4969 | 6744 | 8475 | 9348 |
| | | (E) W 2 | 634 | 1018 | 1354 | 1414 | 2353 | 2320 | 2662 | 4360 | 4187 | 6180 | 6910 | 7620 |
| | | (E) W 1 | 607 | 952 | 1242 | 1232 | 1927 | 2056 | 2279 | 3770 | 3069 | 5642 | 6174 | 6954 |
| | Potenza frigorifera sensibile Sensible cooling capacity Puissance frigorifique sensible Sensible Kälteleistung Potencia frigorífica total sensible | (E) W 6 | 763 | 1445 | 2019 | 2109 | 3136 | 3216 | 3792 | 4284 | 4434 | 6032 | - | - |
| | | (E) W 5 | 680 | 1238 | 1820 | 1880 | 2768 | 2830 | 3255 | 4085 | 4345 | 5732 | 7749 | 8399 |
| | | (E) W 4 | 607 | 1088 | 1557 | 1677 | 2155 | 2481 | 2765 | 3906 | 4156 | 5463 | 6730 | 7280 |
| | | (E) W 3 | 533 | 963 | 1394 | 1485 | 1912 | 2232 | 2390 | 3960 | 3849 | 5054 | 6565 | 7028 |
| | | (E) W 2 | 475 | 868 | 1060 | 1130 | 1913 | 1960 | 2070 | 3630 | 3177 | 4575 | 5270 | 5620 |
| | | (E) W 1 | 447 | 792 | 1012 | 1002 | 1497 | 1717 | 1767 | 3150 | 2309 | 4162 | 4654 | 5084 |
| Portata acqua Water flow Débit d'eau Wassermenge Flujo de agua | (E) l/h 6 | 156 | 277 | 440 | 460 | 642 | 642 | 826 | 998 | 1020 | 1401 | - | - | |
| | (E) l/h 5 | 145 | 232 | 395 | 407 | 572 | 573 | 715 | 948 | 975 | 1327 | 1762 | 1950 | |
| | (E) l/h 4 | 133 | 211 | 357 | 368 | 473 | 505 | 609 | 913 | 945 | 1277 | 1554 | 1715 | |
| | (E) l/h 3 | 122 | 194 | 316 | 326 | 425 | 454 | 533 | 831 | 875 | 1180 | 1492 | 1641 | |
| | (E) l/h 2 | 111 | 179 | 239 | 248 | 411 | 404 | 464 | 696 | 737 | 1083 | 1217 | 1334 | |
| | (E) l/h 1 | 106 | 166 | 217 | 215 | 336 | 358 | 397 | 510 | 542 | 988 | 1085 | 1219 | |
| Perdite di carico lato acqua Water pressure drop Pertes charge côté eau Wasserseitiger Druckverlust Caídas de presión lado agua | (E) kPa 6 | 0,9 | 3,4 | 9,9 | 10,6 | 23,2 | 27,8 | 62,6 | 13,0 | 13,5 | 25,9 | - | - | |
| | (E) kPa 5 | 0,8 | 2,4 | 6,8 | 8,2 | 13,1 | 20,0 | 50,3 | 12,3 | 12,4 | 25,0 | 20,9 | 25,0 | |
| | (E) kPa 4 | 0,7 | 2,1 | 5,7 | 7,2 | 11,0 | 16,0 | 36,5 | 11,1 | 11,8 | 22,0 | 16,8 | 20,0 | |
| | (E) kPa 3 | 0,5 | 1,7 | 4,6 | 5,6 | 8,8 | 13,4 | 29,9 | 9,4 | 10,3 | 20,3 | 17,9 | 20,5 | |
| | (E) kPa 2 | 0,4 | 1,5 | 2,5 | 3,4 | 7,6 | 11,0 | 23,3 | 7,1 | 16,9 | 17,4 | 10,9 | 14,3 | |
| | (E) kPa 1 | 0,5 | 1,4 | 2,8 | 2,8 | 7,4 | 9,9 | 17,2 | 4,0 | 4,4 | 14,0 | 10,1 | 12,1 | |
| 65/55 °C 20 °C | Potenza termica Heating capacity Puissance thermique Heizleistung Energía térmica | (E) W 6 | 1230 | 2040 | 2810 | 2810 | 3730 | 4030 | 5040 | 5950 | 6230 | 7770 | - | - |
| | | (E) W 5 | 1100 | 1870 | 2600 | 2550 | 3400 | 3660 | 4460 | 5660 | 5960 | 7440 | 10010 | 11310 |
| | | (E) W 4 | 970 | 1670 | 2410 | 2340 | 3080 | 3310 | 3800 | 5480 | 5690 | 7240 | 8920 | 10070 |
| | | (E) W 3 | 870 | 1470 | 2160 | 2060 | 2760 | 3060 | 3290 | 5030 | 5320 | 6790 | 8080 | 9110 |
| | | (E) W 2 | 750 | 1320 | 1740 | 1650 | 2450 | 2790 | 2790 | 4340 | 4190 | 6340 | 6850 | 7720 |
| | | (E) W 1 | 700 | 1200 | 1560 | 1440 | 2160 | 2540 | 2500 | 3420 | 3440 | 5900 | 6270 | 7410 |
| | Portata acqua Water flow Débit d'eau Wassermenge Flujo de agua | (E) l/h 6 | 108 | 179 | 246 | 246 | 327 | 353 | 442 | 522 | 546 | 681 | - | - |
| | | (E) l/h 5 | 97 | 164 | 228 | 224 | 298 | 322 | 392 | 497 | 523 | 653 | 878 | 992 |
| | | (E) l/h 4 | 85 | 146 | 212 | 205 | 271 | 291 | 333 | 480 | 499 | 635 | 782 | 883 |
| | | (E) l/h 3 | 76 | 129 | 190 | 181 | 242 | 268 | 290 | 441 | 466 | 596 | 709 | 799 |
| | | (E) l/h 2 | 66 | 116 | 153 | 145 | 215 | 245 | 245 | 382 | 368 | 558 | 600 | 677 |
| | | (E) l/h 1 | 61 | 105 | 137 | 126 | 190 | 223 | 219 | 300 | 302 | 517 | 550 | 650 |
| Perdite di carico lato acqua Water pressure drop Pertes charge côté eau Wasserseitiger Druckverlust Caídas de presión lado agua | (E) kPa 6 | 2,5 | 8,3 | 18,6 | 18,5 | 37,0 | 42,5 | 63,1 | 21,7 | 23,5 | 42,9 | - | - | |
| | (E) kPa 5 | 2,1 | 7,1 | 13,0 | 13,5 | 27,2 | 29,2 | 51,8 | 19,9 | 21,8 | 39,7 | 40,9 | 47,1 | |
| | (E) kPa 4 | 1,7 | 5,8 | 11,5 | 11,6 | 23,1 | 24,1 | 37,4 | 18,8 | 20,1 | 37,8 | 33,0 | 37,9 | |
| | (E) kPa 3 | 1,1 | 4,7 | 9,6 | 9,4 | 18,2 | 21,3 | 28,0 | 16,2 | 17,8 | 33,8 | 27,5 | 31,5 | |
| | (E) kPa 2 | 0,9 | 3,9 | 6,1 | 6,4 | 17,7 | 18,3 | 23,9 | 12,5 | 11,7 | 30,0 | 20,2 | 23,2 | |
| | (E) kPa 1 | 0,9 | 3,3 | 5,1 | 5,7 | 11,6 | 15,6 | 13,6 | 8,2 | 8,3 | 23,7 | 17,1 | 21,5 | |
| 70/60 °C 20 °C | Potenza termica Heating capacity Puissance thermique Heizleistung Energía térmica | (E) W 6 | 1410 | 2310 | 3170 | 3170 | 4210 | 4550 | 5680 | 6700 | 7010 | 8770 | - | - |
| | | (E) W 5 | 1260 | 2120 | 2930 | 2880 | 3840 | 4140 | 5040 | 6390 | 6730 | 8400 | 11340 | 12810 |
| | | (E) W 4 | 1110 | 1890 | 2730 | 2650 | 3490 | 3750 | 4290 | 6180 | 6420 | 8180 | 10080 | 11380 |
| | | (E) W 3 | 990 | 1670 | 2450 | 2330 | 3120 | 3450 | 3710 | 5680 | 5990 | 7670 | 9130 | 10290 |
| | | (E) W 2 | 860 | 1500 | 1970 | 1860 | 2760 | 3150 | 3150 | 4910 | 4730 | 7160 | 7730 | 8720 |
| | | (E) W 1 | 790 | 1360 | 1750 | 1630 | 2450 | 2870 | 2810 | 3850 | 3880 | 6660 | 7080 | 8370 |
| | Portata acqua Water flow Débit d'eau Wassermenge Flujo de agua | (E) l/h 6 | 124 | 203 | 279 | 278 | 370 | 400 | 499 | 589 | 616 | 771 | - | - |
| | | (E) l/h 5 | 111 | 186 | 258 | 253 | 337 | 364 | 442 | 561 | 591 | 738 | 996 | 1125 |
| | | (E) l/h 4 | 98 | 166 | 240 | 232 | 306 | 329 | 377 | 543 | 564 | 718 | 886 | 1000 |
| | | (E) l/h 3 | 87 | 147 | 215 | 205 | 274 | 303 | 326 | 499 | 527 | 674 | 802 | 904 |
| | | (E) l/h 2 | 75 | 132 | 173 | 164 | 243 | 276 | 277 | 431 | 415 | 629 | 679 | 766 |
| | | (E) l/h 1 | 70 | 119 | 154 | 143 | 215 | 252 | 247 | 339 | 341 | 585 | 622 | 736 |
| Perdite di carico lato acqua Water pressure drop Pertes charge côté eau Wasserseitiger Druckverlust Caídas de presión lado agua | (E) kPa 6 | 3,1 | 10,2 | 22,6 | 22,5 | 45,1 | 51,7 | 74,6 | 26,3 | 28,6 | 52,5 | - | - | |
| | (E) kPa 5 | 2,6 | 8,8 | 15,7 | 16,3 | 32,9 | 35,1 | 61,4 | 24,2 | 26,6 | 48,6 | 51,3 | 58,8 | |
| | (E) kPa 4 | 2,1 | 7,2 | 13,8 | 14,1 | 27,9 | 28,9 | 44,3 | 22,9 | 24,4 | 46,3 | 41,2 | 47,2 | |
| | (E) kPa 3 | 1,4 | 5,8 | 11,5 | 11,3 | 21,9 | 25,7 | 32,8 | 19,7 | 21,7 | 41,4 | 34,2 | 39,2 | |
| | (E) kPa 2 | 1,1 | 4,8 | 7,4 | 7,7 | 21,5 | 22,0 | 28,4 | 15,2 | 14,2 | 36,6 | 25,1 | 28,8 | |
| | (E) kPa 1 | 1,1 | 4,0 | 6,1 | 7,0 | 14,0 | 18,8 | 15,7 | 10,0 | 10,1 | 28,9 | 21,3 | 26,7 | |
| Portata aria Air flow Débit d'air Luftstrom Flujo de aire | (E) m³/h 6 | 261 | 388 | 505 | 502 | 769 | 770 | 822 | 1132 | 1029 | 1402 | - | - | |
| | (E) m³/h 5 | 216 | 331 | 437 | 429 | 647 | 650 | 672 | 1051 | 967 | 1297 | 2307 | 2294 | |
| | (E) m³/h 4 | 180 | 274 | 383 | 377 | 545 | 548 | 549 | 998 | 927 | 1230 | 1911 | 1902 | |
| | (E) m³/h 3 | 152 | 231 | 333 | 326 | 469 | 474 | 463 | 876 | 837 | 1102 | 1633 | 1628 | |
| | (E) m³/h 2 | 128 | 199 | 256 | 249 | 399 | 407 | 394 | 693 | 673 | 978 | 1224 | 1230 | |
| | (E) m³/h 1 | 117 | 175 | 217 | 214 | 343 | 350 | 338 | 475 | 466 | 870 | 1050 | 1088 | |
| Livello di potenza sonora Sound power level Niveau de puissance sonore Schall-Leistungspegel Nivel de potencia acústica | (E) dB(A) 6 | 50 | 56 | 50 | 53 | 56 | 57 | 58 | 68 | 68 | 61 | - | - | |
| | (E) dB(A) 5 | 47 | 52 | 47 | 47 | 51 | 53 | 53 | 68 | 68 | 59 | 69 | 69 | |
| | (E) dB(A) 4 | 43 | 47 | 44 | 45 | 46 | 48 | 47 | 66 | 66 | 58 | 66 | 66 | |
| | (E) dB(A) 3 | 36 | 43 | 40 | 41 | 42 | 44 | 43 | 64 | 64 | 56 | 63 | 63 | |
| | (E) dB(A) 2 | 37 | 39 | 34 | 35 | 38 | 41 | 39 | 59 | 59 | 54 | 58 | 58 | |
| | (E) dB(A) 1 | 31 | 34 | 30 | 30 | 35 | 38 | 35 | 52 | 52 | 52 | 55 | 55 | |
| Livello di pressione sonora Sound pressure level Niveau de pression sonore Schall-Druckpegel Nivel de presión sonora | (E) dB(A) 6 | 41 | 47 | 41 | 44 | 47 | 48 | 49 | 59 | 59 | 52 | - | - | |
| | (E) dB(A) 5 | 36 | 43 | 38 | 38 | 42 | 44 | 44 | 59 | 59 | 50 | 60 | 60 | |
| | (E) dB(A) 4 | 31 | 38 | 35 | 36 | 37 | 39 | 38 | 57 | 57 | 49 | 57 | 57 | |
| | (E) dB(A) 3 | 27 | 34 | 31 | 32 | 33 | 35 | 34 | 55 | 55 | 47 | 54 | 54 | |
| | (E) dB(A) 2 | 25 | 30 | 25 | 26 | 29 | 32 | 30 | 50 | 50 | 45 | 49 | 49 | |
| | (E) dB(A) 1 | 22 | 25 | 21 | 21 | 26 | 29 | 26 | 43 | 43 | 43 | 46 | 46 | |

- **Unità standard a bocca libera:** pressione statica esterna = 0 Pa / Il test per la rilevazione del livello di potenza sonora è stato eseguito in accordo con la **normativa EN 16583:2015 / Livello di pressione sonora:** considerata 8,6 dB(A) inferiore rispetto alla potenza sonora in una stanza di 90 m³ con un tempo di riverbero di 0,5 sec. / **Valori tensione ammissibile:** ~230V / 1ph / 50-60Hz
 - **Standard unit with free outlet:** external static pressure = 0 Pa / The sound power level test has been performed according to **EN 16583:2015 standard / Sound pressure level:** 8,6 dB(A) lower than the sound power level for a room of 90 m³ with a reverberation time of 0,5 sec. / **Supported power supply:** ~230V / 1ph / 50-60Hz
 - **Unité standard avec sortie libre:** pression statique externe = 0 Pa / Le test de détection du niveau de puissance acoustique

| Motore asincrono - Asynchronous motor Moteur asynchrone - Asynchronmotor - Motor asíncrono | | | 10 | 20 | 30 | 40 | 50 | 60 | 70 | 80 | 90 | 100 | 110 | 120 |
|--|------|------|-----------------------|-----------|-----------|-----------|-----------|-----------|-----------|------------|------------|------------|------------|------------|
| Potenza assorbita dal motore del ventilatore Motor fan absorbed power Puissance absorbée par le moteur de ventilateur Vom Lüftermotor aufgenommene Leistung Potencia absorbida por el motor del ventilador | (E) | W 6 | 37 | 55 | 61 | 61 | 94 | 94 | 98 | 166 | 166 | 158 | - | - |
| | | W 5 | 30 | 42 | 50 | 50 | 72 | 80 | 76 | 155 | 155 | 148 | 251 | 251 |
| | | W 4 | 23 | 32 | 43 | 43 | 59 | 59 | 59 | 144 | 144 | 137 | 230 | 230 |
| | | W 3 | 17 | 27 | 36 | 35 | 48 | 48 | 50 | 131 | 131 | 126 | 215 | 212 |
| | | W 2 | 16 | 22 | 26 | 26 | 37 | 40 | 40 | 113 | 113 | 117 | 180 | 180 |
| | | W 1 | 13 | 18 | 18 | 18 | 33 | 33 | 33 | 91 | 91 | 108 | 146 | 146 |
| Corrente assorbita dal motore del ventilatore Motor fan absorbed current Courant absorbé par le moteur du ventilateur Vom Lüftermotor aufgenommener Strom Corriente absorbida por el motor del ventilador | (E) | A 6 | 0,17 | 0,25 | 0,26 | 0,26 | 0,40 | 0,40 | 0,43 | 0,79 | 0,79 | 0,72 | - | - |
| | | A 5 | 0,13 | 0,19 | 0,22 | 0,22 | 0,31 | 0,31 | 0,33 | 0,72 | 0,72 | 0,67 | 1,13 | 1,13 |
| | | A 4 | 0,10 | 0,14 | 0,18 | 0,18 | 0,24 | 0,24 | 0,26 | 0,66 | 0,66 | 0,62 | 1,04 | 1,04 |
| | | A 3 | 0,08 | 0,12 | 0,15 | 0,15 | 0,20 | 0,20 | 0,21 | 0,60 | 0,60 | 0,58 | 0,99 | 0,99 |
| | | A 2 | 0,07 | 0,10 | 0,11 | 0,11 | 0,16 | 0,16 | 0,17 | 0,51 | 0,51 | 0,54 | 0,85 | 0,85 |
| A 1 | 0,06 | 0,09 | 0,08 | 0,08 | 0,14 | 0,14 | 0,15 | 0,41 | 0,41 | 0,50 | 0,72 | 0,72 | | |
| Tensione di alimentazione Power supply Tension d'alimentation Stromversorgung Tensión de alimentación | | | ~230V / 1ph / 50-60Hz | | | | | | | | | | | |

velocità cablate / wired speed / vitesse câblée / verkabelte Geschwindigkeitsstufe / velocidades cableadas (E) = Eurovent

| Motore ECM - ECM motor Moteur ECM - ECM-Motor - Motor ECM | | | 10 | 20 | 30 | 40 | 50 | 60 | 70 | 80 | 90 | 100 | 110 | 120 |
|--|-----|------|-----------------------|-----------|-----------|-----------|-----------|-----------|-----------|-----------|------------|-----------|-----|-----|
| Potenza assorbita dal motore del ventilatore Motor fan absorbed power Puissance absorbée par le moteur de ventilateur Vom Lüftermotor aufgenommene Leistung Potencia absorbida por el motor del ventilador | (E) | W 6 | - | 29 | 29 | 29 | 58 | 58 | - | 106 | 119 | 89 | - | - |
| | | W 5 | - | 22 | 21 | 21 | 37 | 37 | 48 | 94 | 110 | 70 | - | - |
| | | W 4 | - | 17 | 15 | 15 | 26 | 26 | 28 | 74 | 88 | 55 | - | - |
| | | W 3 | - | 13 | 12 | 12 | 18 | 18 | 19 | 58 | 67 | 49 | - | - |
| | | W 2 | - | 10 | 8 | 8 | 14 | 14 | 14 | 34 | 40 | 38 | - | - |
| | | W 1 | - | 9 | 7 | 7 | 11 | 11 | 11 | 20 | 24 | 31 | - | - |
| Corrente assorbita dal motore del ventilatore Motor fan absorbed current Courant absorbé par le moteur du ventilateur Vom Lüftermotor aufgenommener Strom Corriente absorbida por el motor del ventilador | (E) | A 6 | - | 0,22 | 0,23 | 0,23 | 0,50 | 0,50 | - | 0,83 | 0,93 | 0,66 | - | - |
| | | A 5 | - | 0,16 | 0,16 | 0,16 | 0,33 | 0,33 | 0,43 | 0,74 | 0,87 | 0,50 | - | - |
| | | A 4 | - | 0,14 | 0,12 | 0,12 | 0,23 | 0,23 | 0,25 | 0,59 | 0,70 | 0,39 | - | - |
| | | A 3 | - | 0,11 | 0,10 | 0,10 | 0,17 | 0,17 | 0,17 | 0,45 | 0,53 | 0,35 | - | - |
| | | A 2 | - | 0,10 | 0,08 | 0,08 | 0,13 | 0,13 | 0,13 | 0,27 | 0,32 | 0,28 | - | - |
| A 1 | - | 0,09 | 0,07 | 0,07 | 0,11 | 0,11 | 0,11 | 0,16 | 0,18 | 0,25 | - | - | | |
| Tensione di controllo velocità (Vcc) Speed control voltage (Vdc) Tension de contrôle de vitesse (Vcc) Drehzahlregelspannung (Vcc) Voltaje de control de velocidad (Vcc) | (E) | V 6 | - | 8,3 | 8,6 | 8,6 | 8,4 | 8,4 | - | 8,1 | 8,1 | 7,7 | - | - |
| | | V 5 | - | 6,8 | 7,1 | 7,1 | 7,0 | 7,0 | 8,3 | 7,8 | 7,9 | 6,9 | - | - |
| | | V 4 | - | 5,5 | 5,6 | 5,5 | 5,9 | 5,8 | 6,3 | 7,1 | 7,2 | 6,1 | - | - |
| | | V 3 | - | 4,2 | 4,6 | 4,5 | 4,8 | 4,8 | 5,1 | 6,4 | 6,5 | 5,8 | - | - |
| | | V 2 | - | 3,3 | 2,9 | 3,3 | 4,5 | 4,0 | 4,1 | 5,1 | 5,1 | 5,0 | - | - |
| V 1 | - | 2,4 | 2,1 | 2,3 | 4,1 | 3,3 | 3,2 | 4,0 | 4,0 | 4,3 | - | - | | |
| Tensione di alimentazione Power supply Tension d'alimentation Stromversorgung Tensión de alimentación | | | ~230V / 1ph / 50-60Hz | | | | | | | | | | | |

velocità cablate / wired speed / vitesse câblée / verkabelte Geschwindigkeitsstufe / velocidades cableadas (E) = Eurovent

Weights and packaging

| | dimensioni | peso netto | peso lordo | bancale | | |
|-----------------|------------------|------------|--------------|-------------|--------------------|-----------|
| | dimension | net weight | gross weight | palette | | |
| | [mm] (AxBxC) | [kg] | [kg] | [mm] L x P | [n.] unità - units | [kg] tot. |
| MOD. 10 | 680 x 235 x 560 | 14 | 15 | 1200 x 800 | 17 | 270 |
| MOD. 20 | 880 x 235 x 560 | 17 | 18 | 1300 x 900 | 17 | 321 |
| MOD. 30 | 1080 x 235 x 560 | 22 | 26 | 1200 x 1000 | 13 | 353 |
| MOD. 40 | 1080 x 235 x 560 | 22 | 24 | 1200 x 1000 | 13 | 327 |
| MOD. 50 | 1280 x 235 x 560 | 26 | 28 | 1300 x 1000 | 13 | 379 |
| MOD. 60 | 1280 x 235 x 560 | 26 | 28 | 1300 x 1000 | 13 | 379 |
| MOD. 70 | 1280 x 235 x 640 | 31 | 33 | 1300 x 1000 | 10 | 345 |
| MOD. 80 | 1480 x 235 x 640 | 36 | 39 | 1500 x 1000 | 10 | 405 |
| MOD. 90 | 1480 x 235 x 640 | 36 | 39 | 1500 x 1000 | 10 | 405 |
| MOD. 100 | 1680 x 270 x 640 | 48 | 51 | 1800 x 900 | 7 | 380 |
| MOD. 110 | 1980 x 270 x 640 | 56 | 60 | 2000 x 900 | 7 | 450 |
| MOD. 120 | 1980 x 270 x 640 | 56 | 60 | 2000 x 900 | 7 | 450 |

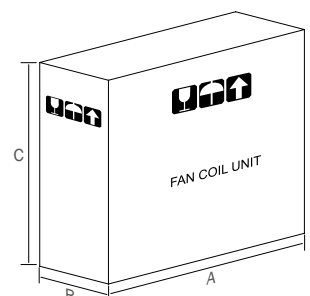

| Con mobile / With cabinet Avec carrosserie / Mit Gehäuse / Con mueble | | | 10 | 20 | 30 | 40 | 50 | 60 | 70 | 80 | 90 | 100 | 110 | 120 |
|--|---|----|-----|-----|------|------|------|------|------|------|------|------|------|------|
| Lunghezza / Length / Longueur / Länge / Longitud | L | mm | 660 | 860 | 1060 | 1060 | 1260 | 1260 | 1260 | 1460 | 1460 | 1660 | 1960 | 1960 |
| Altezza / Height / Hauteur / Höhe / Altura | H | mm | 480 | 480 | 480 | 480 | 480 | 480 | 585 | 585 | 585 | 605 | 605 | 605 |
| Profondità / Depth / Profondeur / Tiefe / Profundidad | P | mm | 225 | 225 | 225 | 225 | 225 | 225 | 225 | 225 | 225 | 257 | 257 | 257 |
| Senza mobile / Without cabinet Sans carrosserie / Ohne Gehäuse / Sin mueble | | | 10 | 20 | 30 | 40 | 50 | 60 | 70 | 80 | 90 | 100 | 110 | 120 |
| Lunghezza / Length / Longueur / Länge / Longitud | L | mm | 420 | 620 | 820 | 820 | 1020 | 1020 | 1020 | 1220 | 1220 | 1385 | 1685 | 1685 |
| Altezza / Height / Hauteur / Höhe / Altura | H | mm | 460 | 460 | 460 | 460 | 460 | 460 | 565 | 565 | 565 | 585 | 585 | 585 |
| Profondità / Depth / Profondeur / Tiefe / Profundidad | P | mm | 220 | 220 | 220 | 220 | 220 | 220 | 220 | 220 | 220 | 252 | 252 | 252 |

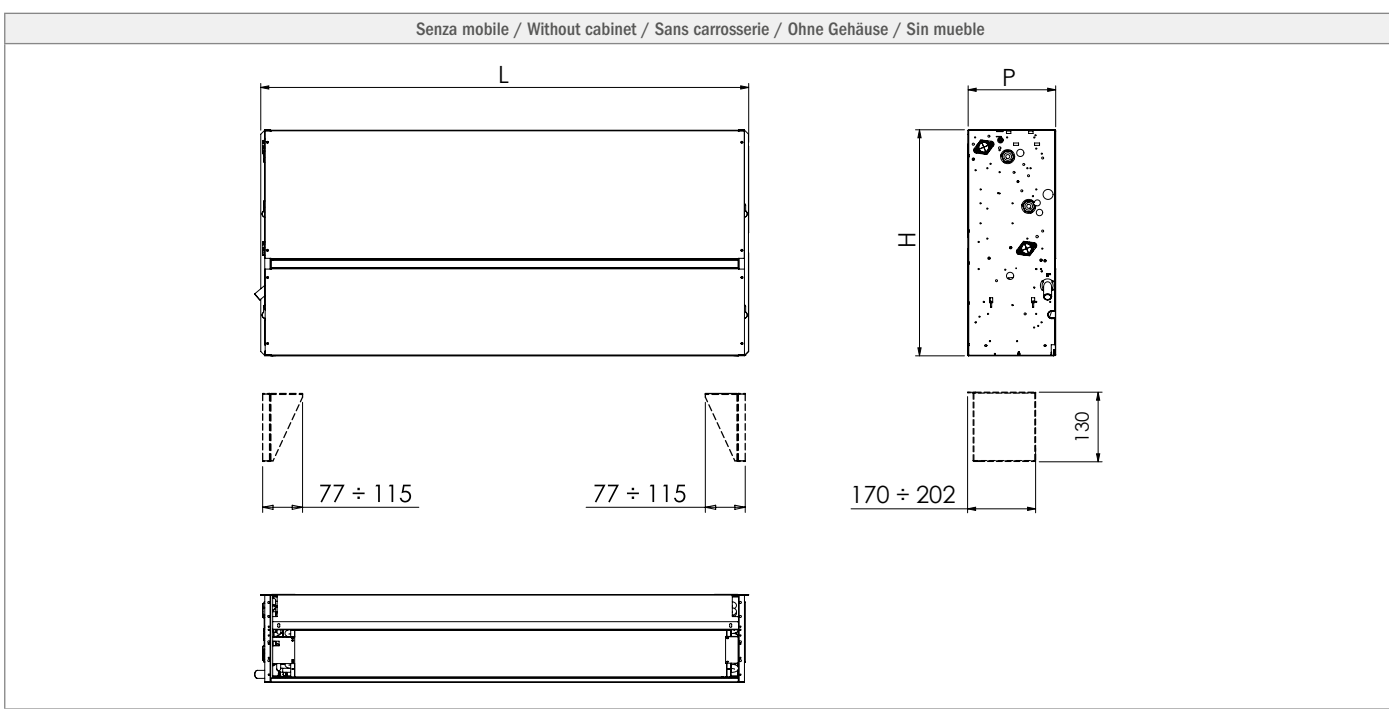
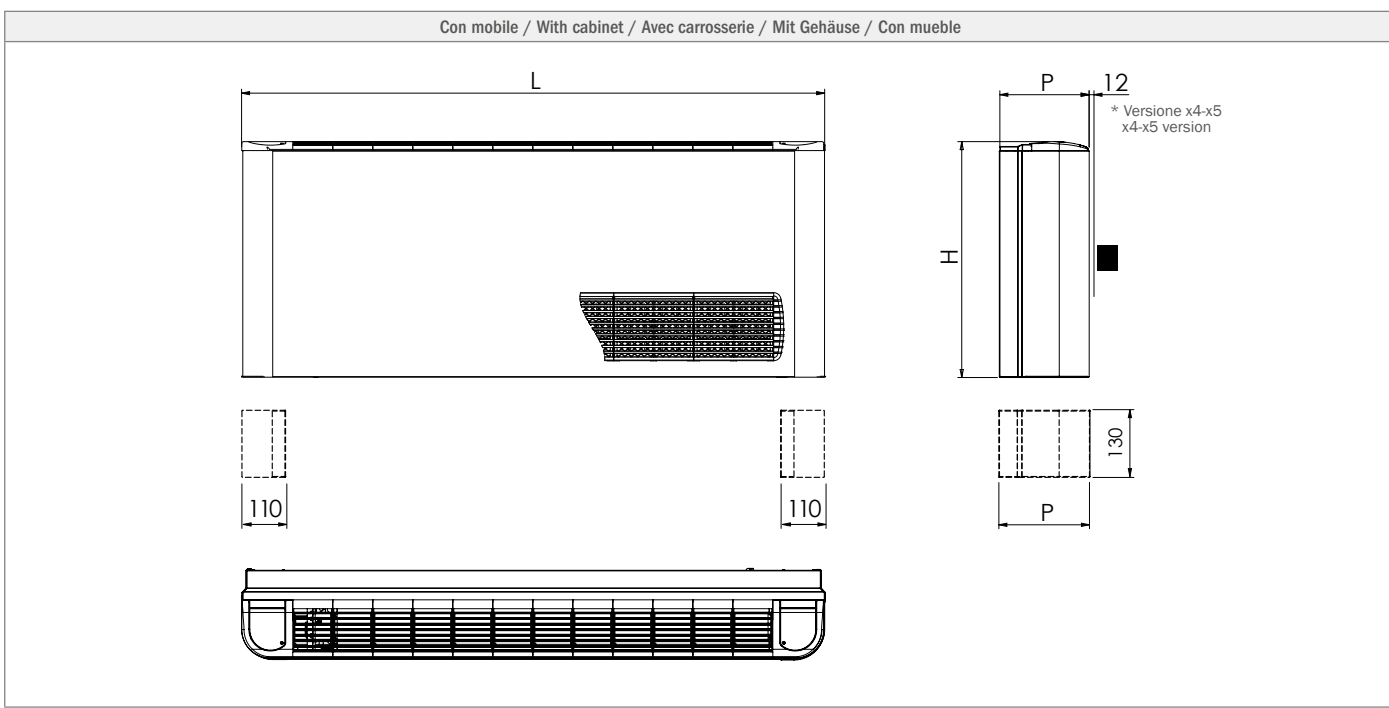

Concealed panel

WIND | WIND-ECM

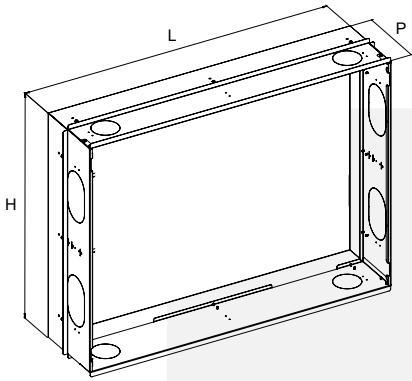

MNFP-W

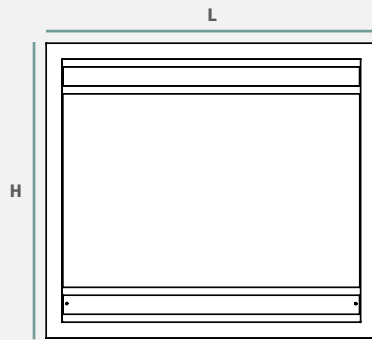

WIND X2-X3

| | technical spaces size | front panel size |
|---------|-----------------------|-------------------|
| MOD. 10 | 780 x 220 x (H)690 | 840 x 7 x (H)750 |
| MOD. 20 | 930 x 220 x (H)690 | 990 x 7 x (H)750 |
| MOD. 30 | 1080 x 220 x (H)690 | 1140 x 7 x (H)750 |
| MOD. 40 | 1080 x 220 x (H)690 | 1140 x 7 x (H)750 |
| MOD. 50 | 1380 x 220 x (H)690 | 1440 x 7 x (H)750 |
| MOD. 60 | 1380 x 220 x (H)690 | 1440 x 7 x (H)750 |
| MOD. 70 | 1380 x 220 x (H)775 | 1440 x 7 x (H)835 |
| MOD. 80 | 1530 x 220 x (H)775 | 1590 x 7 x (H)835 |
| MOD. 90 | 1530 x 220 x (H)775 | 1590 x 7 x (H)835 |

L x P x H (mm)

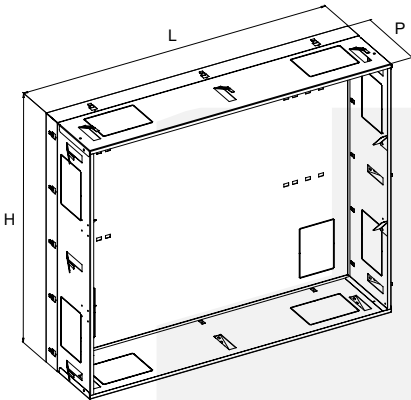

MFP-W

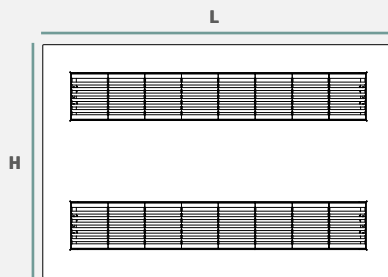

WFP-W

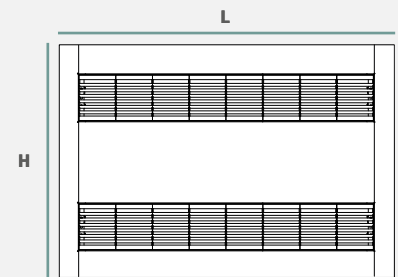

| | technical spaces size | WIND X7 front panel size | WIND X2-X3 front panel size | WIND X7 front panel size | WIND X2-X3 front panel size |
|---------|-----------------------|-----------------------------|--------------------------------|-----------------------------|--------------------------------|
| MOD. 10 | 615 x 227 x (H)675 | 650 x 22 x (H)735 | 650 x 22 x (H)895 | 650 x 20 x (H)720 | 650 x 20 x (H)880 |
| MOD. 20 | 815 x 227 x (H)675 | 850 x 22 x (H)735 | 850 x 22 x (H)895 | 850 x 20 x (H)720 | 850 x 20 x (H)880 |
| MOD. 30 | 1015 x 227 x (H)675 | 1050 x 22 x (H)735 | 1050 x 22 x (H)895 | 1050 x 20 x (H)720 | 1050 x 20 x (H)880 |
| MOD. 40 | 1015 x 227 x (H)675 | 1050 x 22 x (H)735 | 1050 x 22 x (H)895 | 1050 x 20 x (H)720 | 1050 x 20 x (H)880 |
| MOD. 50 | 1215 x 227 x (H)675 | 1250 x 22 x (H)735 | 1250 x 22 x (H)895 | 1250 x 20 x (H)720 | 1250 x 20 x (H)880 |
| MOD. 60 | 1215 x 227 x (H)675 | 1250 x 22 x (H)735 | 1250 x 22 x (H)895 | 1250 x 20 x (H)720 | 1250 x 20 x (H)880 |
| MOD. 70 | 1215 x 227 x (H)780 | 1250 x 22 x (H)840 | 1250 x 22 x (H)1000 | 1250 x 20 x (H)825 | 1250 x 20 x (H)985 |
| MOD. 80 | 1415 x 227 x (H)780 | 1450 x 22 x (H)840 | 1450 x 22 x (H)1000 | 1450 x 20 x (H)825 | 1450 x 20 x (H)985 |
| MOD. 90 | 1415 x 227 x (H)780 | 1450 x 22 x (H)840 | 1450 x 22 x (H)1000 | 1450 x 20 x (H)825 | 1450 x 20 x (H)985 |

L x P x H (mm)

The series lends itself to be easily installed also in the built-in version through the special niche and its front panel specially designed and developed in multiple configurations and variants in order to satisfy any application need.

This installation method, in addition to ensuring perfect integration of the unit within the environment, allows at the same time to recover more living space, offering the possibility of confining the unit and any accessories supplied inside the niche, specially sized to ensure total accessibility during the installation and maintenance phases.

WIND Concealed panel versions

MNFP-W

Panel for vertical and horizontal units, of limited thickness (7 mm only), made of hot-dip galvanized steel powder coated in white RAL 9003 color with directional air delivery flap.

The whole can be painted on site with the same color as the wall.

MFP-W

Panel for vertical and horizontal units, of limited thickness (3mm only), made of hot-galvanized sheet metal and pre-coated with a polyvinyl chloride film to guarantee high corrosion resistance, in matt white RAL 9010 color.

The grilles are instead made of ABS, in matt white RAL 9010.

The panel is also available in the galvanized version that can be painted on site.

WFP-W

Panel for vertical units only made of wood (MDF) lacquered matt white RAL 9010 with ABS grills in matt white RAL 9010.

Also available in the paintable version on site.

All the panels listed above can be supplied, on request, also in other colors or with special finishes.

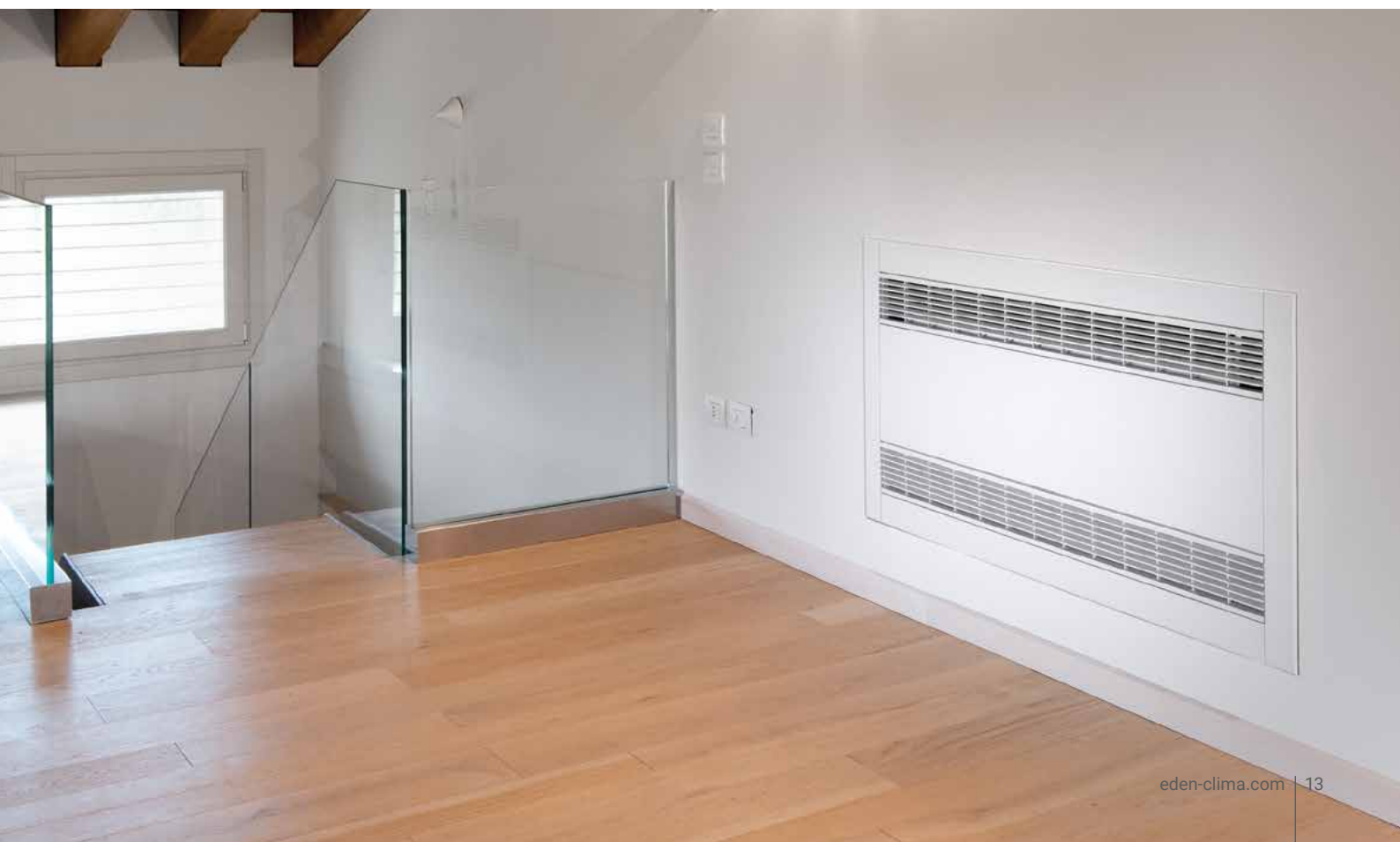

Independent balancing valve

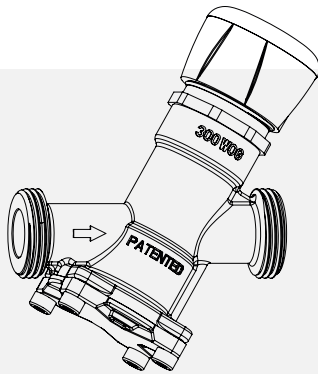

This type of valve combines two functions in a single valve, keeps the flow rate constant as the system pressure changes and at the same time regulates the flow according to the temperature, allowing perfect balancing of the hydraulic system, ensuring for each fan coil unit the desired water flow even under partial loads.

The adjustment can be performed automatically through the installation of a linear ON / OFF or modulating actuator.

Main advantages:

- Simplified selection
- Easy installation
- High valve authority which remains constant
- Constant flow rate as the differential pressure changes
- Optimized installation by measuring the set pressure
- Energy efficiency thanks to the low differential pressure required
- Maintenance of the set water flow even at partial loads
- Optimization of pump speed using pressure taps (optional)
- Preset locked by hooking

Valve performance technical data

Attention: this type of valve is available only for units in the built-in version.

For any combinations on units with a cover cabinet, please contact our sales department.

| 2 tubi - pipes - tubes Leiter - tubos | | 10 | 20 | 30 | 40 | 50 | 60 | 70 | 80 | 90 | 100 | 110 | 120 | |
|---|-----|-------|-------|-------|-------|-------|-------|-------|-------|-------|-------|-------|-------|-------|
| | DN | DN 15 | DN 15 | DN 15 | DN 15 | DN 20 | DN 20 | DN 20 | DN 20 | DN 20 | DN 25 | DN 25 | DN 25 | |
| Attacchi idraulici - Hydraulic connections Raccords hydrauliques - Hydraulikanschlüsse - Conexiones hidráulicas | ø | 3/4" | 3/4" | 3/4" | 3/4" | 1" | 1" | 1" | 1" | 1" | 1"1/4 | 1"1/4 | 1"1/4 | |
| Portata acqua valvola - Valve water flow Débit d'eau valve - Wassermenge am Ventil - Caudal de agua de la válvula | l/s | min | 0,030 | 0,030 | 0,030 | 0,030 | 0,062 | 0,062 | 0,062 | 0,062 | 0,12 | 0,12 | 0,12 | |
| | | max | 0,150 | 0,150 | 0,150 | 0,150 | 0,311 | 0,311 | 0,311 | 0,311 | 0,311 | 0,6 | 0,6 | 0,6 |
| Portata acqua unità - Unit water flow Débit d'eau unité - Wasserdurchfluss des Gerätes - Caudal de agua de la unidad | l/s | min | 0,030 | 0,048 | 0,062 | 0,062 | 0,105 | 0,116 | 0,118 | 0,148 | 0,164 | 0,283 | 0,311 | 0,348 |
| | | max | 0,044 | 0,083 | 0,127 | 0,135 | 0,187 | 0,206 | 0,239 | 0,296 | 0,302 | 0,404 | 0,536 | 0,567 |

| 4 tubi (scambiatore ausiliario) - pipes (auxiliary coil) tubes (batterie auxiliaire) - Leiter (Zusatzwärmetauscher) - tubos (batería auxiliar) | | 10 | 20 | 30 | 40 | 50 | 60 | 70 | 80 | 90 | 100 | 110 | 120 | |
|---|-----|-------|-------|-------|-------|-------|-------|-------|-------|-------|-------|-------|-------|-------|
| | DN | DN 15 | DN 15 | DN 15 | DN 15 | DN 15 | DN 15 | DN 15 | DN 20 | DN 20 | DN 20 | DN 20 | DN 20 | |
| Attacchi idraulici - Hydraulic connections Raccords hydrauliques - Hydraulikanschlüsse - Conexiones hidráulicas | ø | 3/4" | 3/4" | 3/4" | 3/4" | 3/4" | 3/4" | 3/4" | 1" | 1" | 1" | 1" | 1" | |
| Portata acqua valvola - Valve water flow Débit d'eau valve - Wassermenge am Ventil - Caudal de agua de la válvula | l/s | min | 0,030 | 0,030 | 0,030 | 0,030 | 0,030 | 0,030 | 0,062 | 0,062 | 0,062 | 0,062 | 0,062 | |
| | | max | 0,150 | 0,150 | 0,150 | 0,150 | 0,150 | 0,150 | 0,150 | 0,311 | 0,311 | 0,311 | 0,311 | 0,311 |
| Portata acqua unità - Unit water flow Débit d'eau unité - Wasserdurchfluss des Gerätes - Caudal de agua de la unidad | l/s | min | 0,019 | 0,033 | 0,043 | 0,040 | 0,060 | 0,070 | 0,069 | 0,094 | 0,095 | 0,163 | 0,173 | 0,204 |
| | | max | 0,034 | 0,056 | 0,078 | 0,077 | 0,103 | 0,111 | 0,139 | 0,164 | 0,171 | 0,214 | 0,277 | 0,313 |

Presetting and nomograms

In accordance with the principles of dynamic balancing, presetting allows you to set the maximum flow rate of the valve, i.e. the flow rate which will be kept constant within the differential pressure range of use, with the valve fully open. The presetting affects the minimum differential pressure of use of the valve.

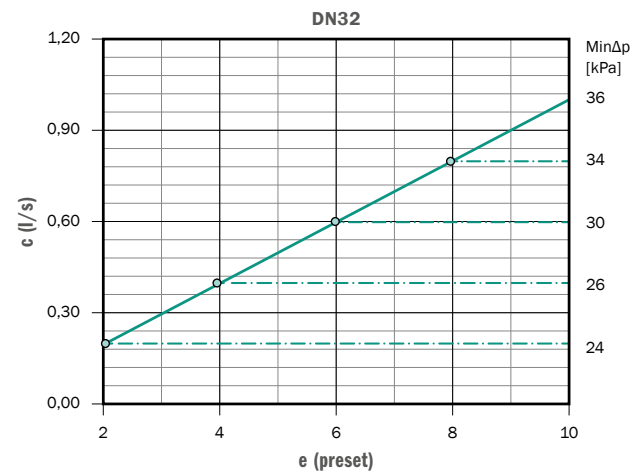
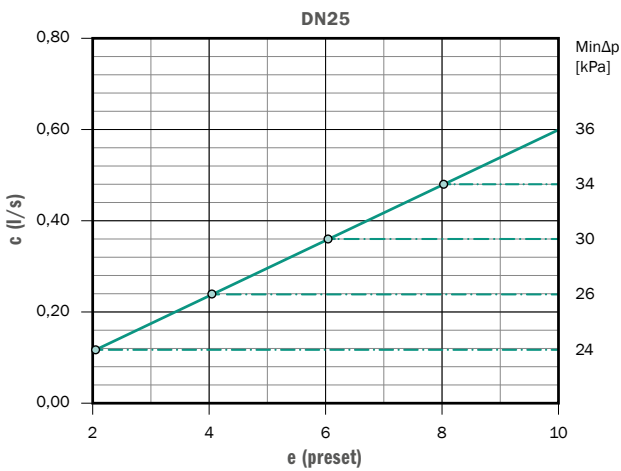
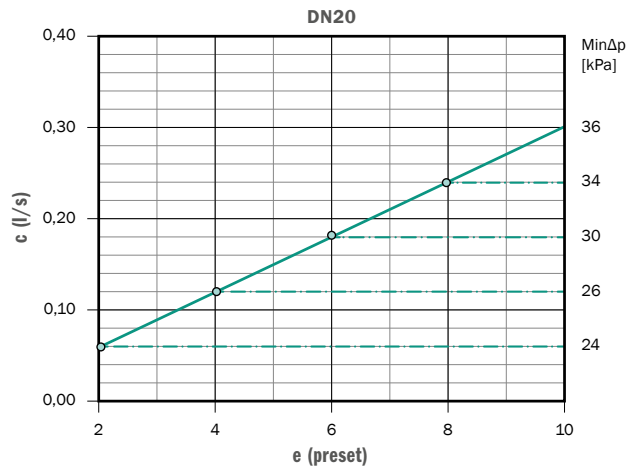
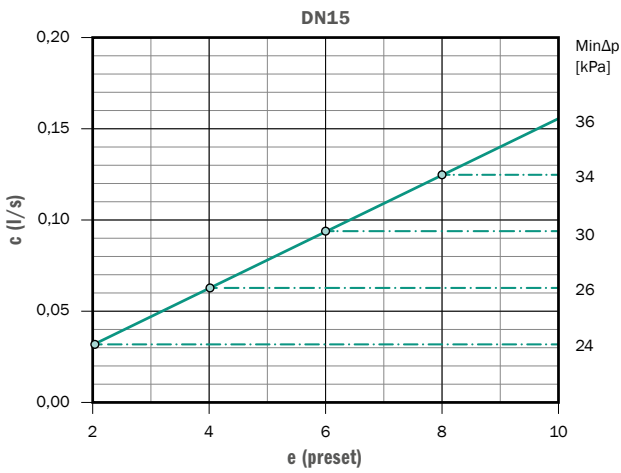
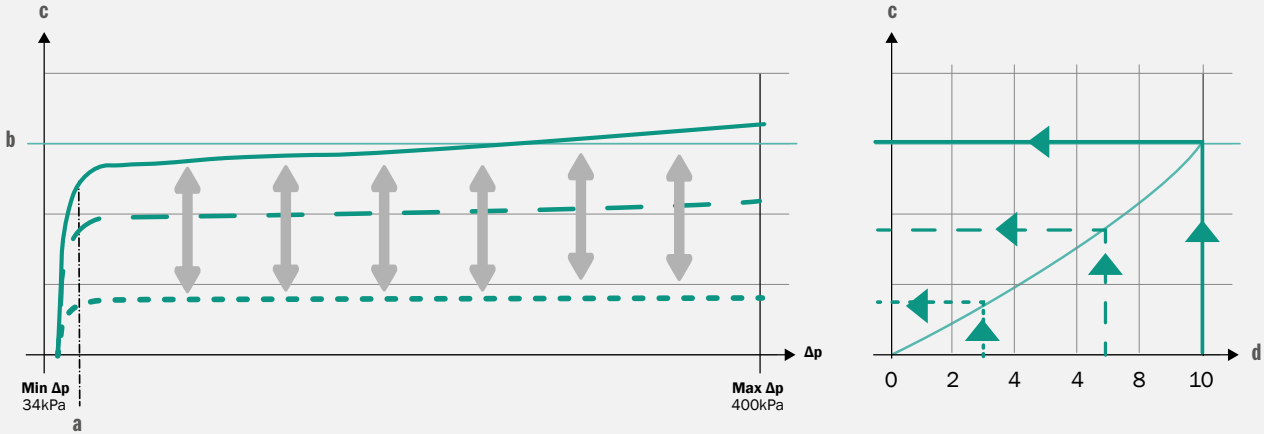

| | |
|----------------|--|
| a | Funzione di prerogolazione / Preset function / Fonction de pré-réglage / Voreingestellte Funktion / Función preestablecida |
| b | Portata prerogolata / Preset flow rate / Débit pré-réglé / Voreingestellte Durchflussmenge / Caudal preestablecido |
| c (l/s) | Portata / Flow / Débit / Durchflussrate / Caudal |
| d | Segnale / Signal / Signal / Signal / Señal |
| e | Prerogolazione / Preset / Pré-réglage / Voreinstellung / Preajuste |

The series can be equipped with a wide range of accessories specifically designed and selected to be able to offer the customer solutions that can respond to every system requirement.

Where provided, the accessories can also be supplied already installed and tested in the company, or supplied separately. For the complete list of available accessories, please refer to the price-list catalog.

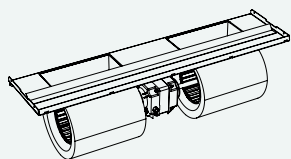

Fan section:

In addition to the asynchronous motor and the Brushless ECM motor, the series can also be supplied with high head motors or motors equipped with thermal protection (fail contact). On request also motors with special requirements.

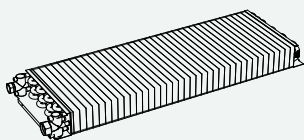

Coils:

4-row coils for 2-pipe systems, 1 row for 4-pipe systems, R410A DX coil. On request also special coils made with special materials or treatments for corrosive atmospheres or with technical precautions to be able to operate at special pressures.

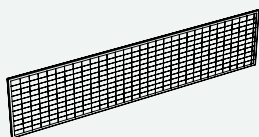

Filters:

in addition to the basic filter supplied with G1 * / EU1 ** efficiency standards, the series can also be equipped with G2 * / EU2 ** or G3 * / EU3 ** filters. (* according to EN779 / ** according to Eurovent)

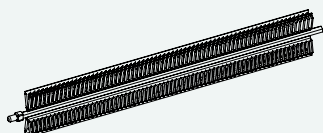

Electric heaters:

electric heater kit from 600W to 3000W, equipped with safety thermostat, 230Vac / 1Ph / 50-60Hz.

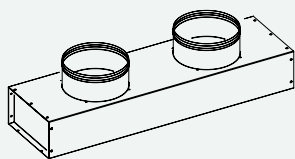

Plenum:

wide range of plenums, ducts, return / supply vents and flexible connection for every installation requirement. Fully customized plenums can also be made on request.

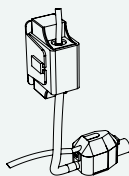

Auxiliary condensate drain pump

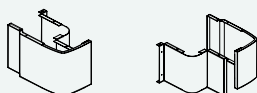

Recessed feet and floor fixing brackets

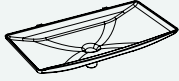

Auxiliary condensate drain pan:

for horizontal or vertical units

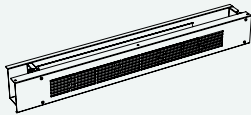

Air intake damper kit:

for horizontal or vertical units (primary air, max 8%), can also be equipped with servomotor for motorized opening.

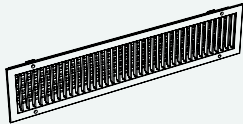

Grills:

supply or intake grills adjustable or fixed type made of anodized aluminium, also in the version already complete with integrated filter.

The grills can also be painted on request with the RAL color of your choice.

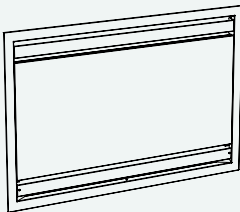

Panels and technical spaces:

wide range of front cover panels in multiple configurations, finishes and thicknesses, with relative recessed technical spaces.

Also available the rear cover panel for installation on glass.

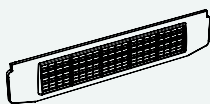

Bottom closure:

in pre-painted sheet metal also available with return grid and integrated air filter.

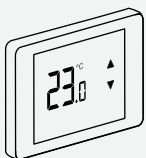

Control:

wide range of control devices and related accessories that allow you to manage the correct room temperature. Multiple solutions available based on the installation type, the required performances and the type of investment.

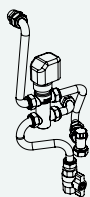

Valves:

wide range of valves, on / off, modulating, floating, two and three ways, which can be supplied already installed and tested or supplied pre-assembled but loose. Also available are the innovative dynamic balancing valves that guarantee effective flow stabilization by controlling the differential pressure, ensuring a constant flow capable of reducing operating costs and higher system efficiency.

Compatibility of controls

For the complete specifications of the controls, please refer to the part relating to the controls, available from page 298.

| | | | |
|------------------|--|------------------------|--|
| 503FA | <ul style="list-style-type: none"> - Termostato elettronico con display LCD - Electronic thermostat with LCD display - Thermostat électronique avec écran LCD - Elektronisches Thermostat mit LCD-Display - Termostato electrónico con pantalla LCD | i-Basic 3 | <ul style="list-style-type: none"> - Termostato elettronico analogico con programmazione semplificata a DIP-SWITCH - Analog electronic thermostat with simplified DIP-SWITCH programming - Thermostat électronique analogique avec programmation simplifiée à DIP-SWITCH - Analoger elektronischer Thermostat mit vereinfachter DIP-Schalter Programmierung - Termostato electrónico analógico con programación simplificada DIP-SWITCH |
| CD11 | <ul style="list-style-type: none"> - Comando senza regolazione di temperatura - Control without temperature control - Commande sans réglage de température - Steuerung ohne Temperaturregelung - Control sin regulación de temperatura | i-Com | <ul style="list-style-type: none"> - Comando senza regolazione di temperatura - Base switch without temperature control - Commande sans réglage de température - Regler für Geräte für 2-Leiter oder 4-Leiter-System ohne Temperaturregelung - Control sin regulación de temperatura |
| COM-B | <ul style="list-style-type: none"> - Commutatore 3 velocità con selettore rotativo BTicino - BTicino rotary selector switch - Commutateur 3 vitesses avec sélecteur rotatif BTicino - Umschalter der 3 Geschwindigkeitsstufen mittels Wahlschalter BTicino - Conmutador de 3 velocidades con selector giratorio b-Ticino | i-Digit 0-1-2-3 | <ul style="list-style-type: none"> - Termostato elettronico programmabile con display LCD - Programmable electronic thermostat with LCD display - Thermostat électronique programmable avec écran LCD - Elektronischer Thermostat für Gebläsekonvektoren mit 2-Leiter oder 4-Leiter-System, mit LCD-Display - Termostato electrónico programable con pantalla LCD |
| COM-V | <ul style="list-style-type: none"> - Commutatore 3 velocità con selettore a slitta Vimar - Vimar 3-speed slide selector - Commutateur 3 vitesses avec sélecteur à glissière Vimar - Umschalter der 3 Geschwindigkeitsstufen mittels Schiebeselector Vimar - Conmutador de 3 velocidades con selector deslizante Vimar | IR-C | <ul style="list-style-type: none"> - Telecomando a raggi infrarossi (per cassette e sistemi TRI/F1 2.0 + S-MOD) - Infrared remote control (for cassette and TRI/F1 2.0 + S-MOD systems) - Télécommande à infrarouges (pour cassette et TRI/F1 2.0 + S-MOD systèmes) - Infrarot-Fernbedienung (für Kassettengeräte und TRI/F1 2.0 + S-MOD Systeme) - Control remoto IR (para fancoil de tipo cassette e sistemas TRI/F1 2.0 + S-MOD) |
| FAN01 | <ul style="list-style-type: none"> - Regolatore per fan coil configurabile con protocollo di comunicazione BACnet - Configurable fan coil controller with BACnet communication protocol - Régulateur pour ventiloconvecteur configurable avec protocole de communication BACnet - Regler für Gebläsekonvektor konfigurierbar über Kommunikationsprotokoll BACnet - Controlador fancoil configurable con protocolo de comunicación BACnet | IR-T | <ul style="list-style-type: none"> - Telecomando a raggi infrarossi (per unità a parete) - Infrared remote control (for wall unit) - Télécommande à infrarouges (pour unité murale) - Infrarot-Fernbedienung für wandmontierte Geräte - Control remoto IR (para unidad de pared) |
| i-10 | <ul style="list-style-type: none"> - Termostato elettronico analogico base (unità a 2 e 4 tubi) - Analog electronic thermostat (2 and 4 pipe units) - Thermostat électronique analogique base (unité à 2 et 4 tubes) - Analoger elektronischer Basisthermostat für Geräte mit 2-Leiter- oder 4-Leiter-System - Termostato electrónico analógico base (unidades de 2 y 4 tubos) | QCB | <ul style="list-style-type: none"> - Quadro comando base - Base control panel - Panneau de contrôle base - Basisbediengerät - Panel de control base |
| i-20 | <ul style="list-style-type: none"> - Termostato elettronico analogico (unità a 2 tubi) - Analog electronic thermostat (2 pipe units) - Thermostat électronique analogique (unité à 2 tubes) - Analoger elektronischer Thermostat für Geräte mit 2-Leiter-System - Termostato electrónico analógico (unidad de 2 tubos) | QCL | <ul style="list-style-type: none"> - Quadro comando base in lamiera - Sheet base control panel - Panneau de contrôle base en tôle - Basisbediengerät aus Metall - Panel de control base en chapa |
| i-25 | <ul style="list-style-type: none"> - Termostato elettronico analogico (unità a 4 tubi) - Analog electronic thermostat (4 pipe units) - Thermostat électronique analogique (unité à 4 tubes) - Analoger elektronischer Thermostat für Geräte mit 4-Leiter-System - Termostato electrónico analógico (unidad de 4 tubos) | QEL | <ul style="list-style-type: none"> - Quadro comando base in lamiera - Sheet base control panel - Panneau de contrôle base en tôle - Basisbediengerät aus Metall - Panel de control base en chapa |
| i-30 | <ul style="list-style-type: none"> - Termostato elettronico programmabile con display LCD - Programmable electronic thermostat with LCD display - Thermostat électronique programmable avec écran LCD - Programmierbarer elektronischer Thermostat für Gebläsekonvektoren mit 2/4-Leiter-System, mit LCD-Display - Termostato electrónico programable con pantalla LCD | QTE | <ul style="list-style-type: none"> - Quadro comando base con termostato ambiente elettronico - Base control panel with electronic room thermostat - Panneau de contrôle base avec thermostat ambient électronique - Basisbediengerät mit elektronischem Raumthermostat - Panel de control base con termostato ambiente electrónico |
| i-50 | <ul style="list-style-type: none"> - Termostato elettronico programmabile con display LCD - Programmable electronic thermostat with LCD display - Thermostat électronique programmable avec écran LCD - Programmierbarer elektronischer Thermostat für Gebläsekonvektoren mit 2/4-Leiter-System, mit LCD-Display - Termostato electrónico programable con pantalla LCD | QTM | <ul style="list-style-type: none"> - Quadro comando base con termostato ambiente elettromeccanico (a bulbo) - Base control panel with room electromechanical temperature bulb thermostat - Panneau de contrôle base avec thermostat ambient électromécanique (à bulbe) - Basischalttafel mit elektromechanischem Raumtempertur-Thermostat (mit Stabfühler) - Panel de control base con termostato ambiente electromecánico (a bulbo) |
| i-60 | <ul style="list-style-type: none"> - Termostato elettronico touch con connessione WiFi per gestione remota - Touch fan coil thermostat with WiFi connection - Thermostat électronique tactile avec connexion WiFi pour gestion à distance - Elektronischer Touch-Thermostat mit WiFi-Anbindung für Fernüberwachung - Termostato electrónico Touch con conexión WiFi para gestión remota | RWIECM 1-2 | <ul style="list-style-type: none"> - Interfaccia utente a parete - Wall user interface - Interface utilisateur mural - Wandmontiertes Bediengerät - Interfaz de usuario de pared |
| i-70 | <ul style="list-style-type: none"> - Termostato elettronico touch configurabile, con protocollo di comunicazione MODbus/BACnet (unità a 2 e 4 tubi) - Touch programmable electronic thermostat with MODbus/BACnet protocol communication (unit 2 and 4 pipe system) - Thermostat électronique tactile configurable, avec protocole de communication MODbus/BACnet (unité à 2 et 4 tubes) - Konfigurierbarer elektronischer Touch-Thermostat, mit MODbus/BACnet-Kommunikation mit 2/4-Leiter-System - Termostato electrónico Touch configurable, con protocolo de comunicación Modbus / Bacnet (unidades de 2 y 4 tubos) | S-MOD | <ul style="list-style-type: none"> - Sistema di supervisione - Supervision system - Système de supervision - Überwachungssystem - Sistema de supervisión |
| i-Basic 1 | <ul style="list-style-type: none"> - Termostato elettronico analogico base - Analog base electronic thermostat - Thermostat électronique analogique base - Analoger elektronischer Basisthermostat für Geräte mit 2-Leiter oder 4-Leiter-System - Termostato electrónico analógico base | TRI/F1 2.0 | <ul style="list-style-type: none"> - Controllo con telecomando IR o interfaccia a muro con protocollo di comunicazione MODbus - Infrared remote controller or wall controller with MODbus communication protocol - Contrôle avec télécommande IR ou interface mural avec protocole de communication MODbus - Steuerung mittels Infrarot-Fernbedienung oder wandmontiertes Bedienfeld mit MODbus-Kommunikationsprotokoll - Control con mando IR o interfaz de pared con protocolo de comunicación MODbus |
| i-Basic 2 | <ul style="list-style-type: none"> - Termostato elettronico analogico - Analog electronic thermostat - Thermostat électronique analogique - Analoger elektronischer Thermostat für Geräte mit 2-Leiter oder 4-Leiter-System - Termostato electrónico analógico | | |

Compatibility of controls

Scheda di potenza per controllo a 3 velocità
 Power chart for 3-speed control
 Fiche de puissance pour contrôle à 3 vitesses
 Leistungsplatine zur Steuerung mit 3 Geschwindigkeiten
 Tarjeta de alimentación para el control de 3 velocidades

| | i-Com | i-Basic 1 | i-Basic 2 | i-Basic 3 | i-Digit 0-1-2-3 | TRI/F1 2.0 | CD11 | i-10 | i-20 | i-25 | i-30 | i-50 | i-60 | i-70 | 503FA | 503BUS+DIN5 | S-MOD | FAN01 |
|----------|-------|-----------|-----------|-----------|-----------------|------------|------|------|------|------|------|------|------|------|-------|-------------|-------|-------|
| Mod. 10 | . | . | . | . | . | . | . | . | . | . | . | . | . | . | . | . | . | . |
| Mod. 20 | . | . | . | . | . | . | . | . | . | . | . | . | . | . | . | . | . | . |
| Mod. 30 | . | . | . | . | . | . | . | . | . | . | . | . | . | . | . | . | . | . |
| Mod. 40 | . | . | . | . | . | . | . | . | . | . | . | . | . | . | . | . | . | . |
| Mod. 50 | . | . | . | . | . | . | . | . | . | . | . | . | . | . | . | . | . | . |
| Mod. 60 | . | . | . | . | . | . | . | . | . | . | . | . | . | . | . | . | . | . |
| Mod. 70 | . | . | . | . | . | . | . | . | . | . | . | . | . | . | . | . | . | . |
| Mod. 80 | . | . | ○ | ○ | ○ | . | . | . | . | . | . | . | ○ | ○ | . | . | . | . |
| Mod. 90 | . | . | ○ | ○ | ○ | . | . | . | . | . | . | . | ○ | ○ | . | . | . | . |
| Mod. 100 | . | . | ○ | ○ | ○ | . | . | . | . | . | . | . | ○ | ○ | . | . | . | . |
| Mod. 110 | . | . | ○ | ○ | ○ | . | . | . | . | . | . | . | ○ | ○ | . | . | . | . |
| Mod. 120 | . | . | ○ | ○ | ○ | . | . | . | . | . | . | . | ○ | ○ | . | . | . | . |

WIND | WIND-ECM

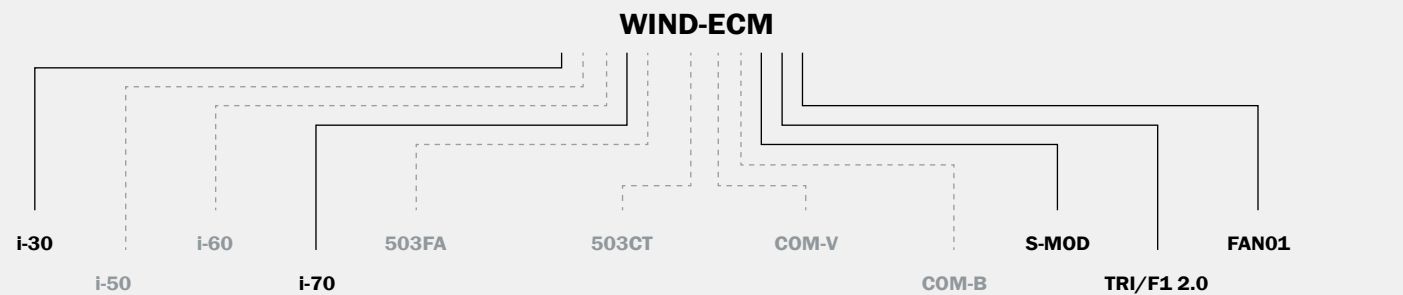
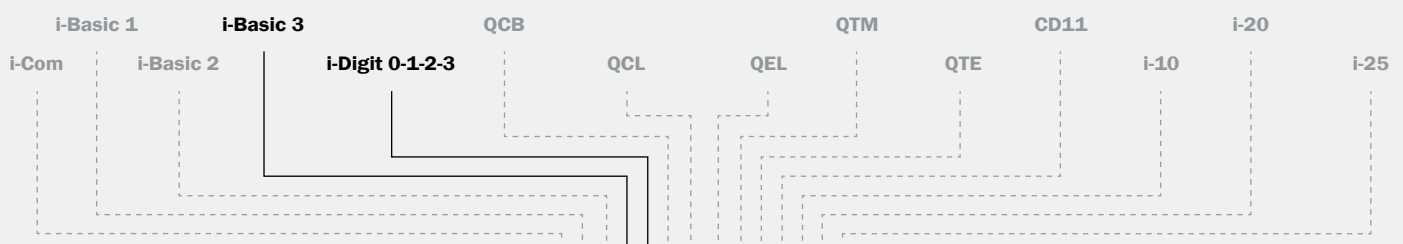
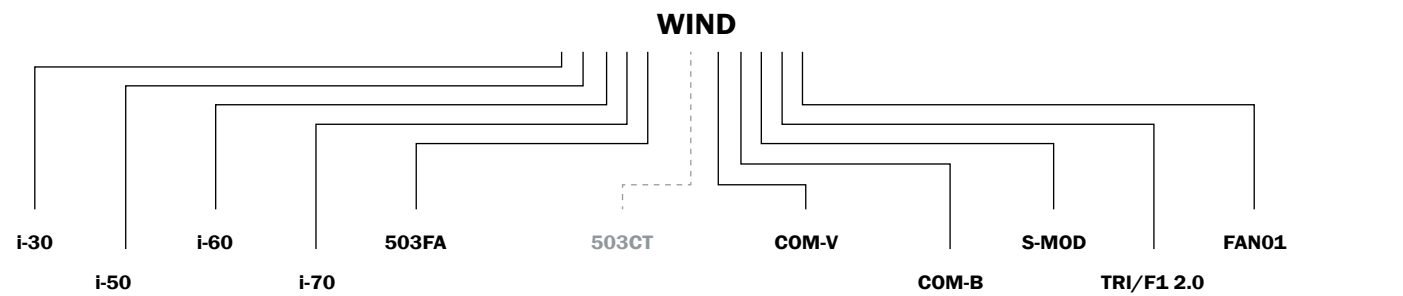
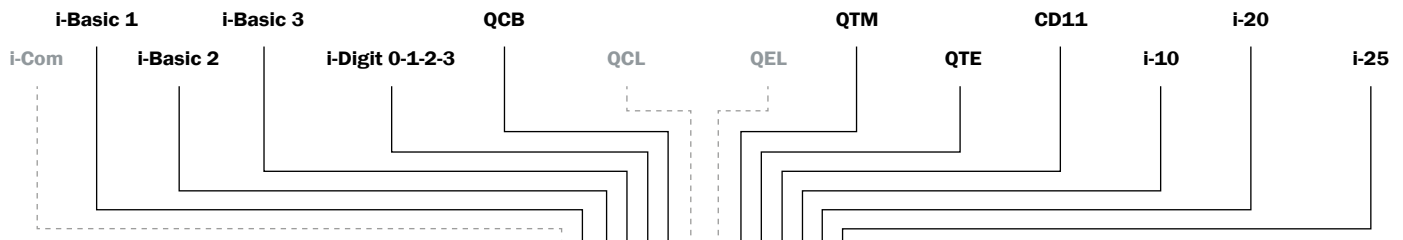

- Compatible
Compatible
Compatible
Kompatibel
Compatible
- - - Non compatibile
Not compatible
Non compatible
Nicht kompatibel
NO compatible
- Non necessaria
Not necessary
Non nécessaire
Nicht erforderlich
No Requerido
- Necessaria (inclusa di serie)
Necessary (included as standard)
Nécessaire (comprise de série)
Erforderlich (serienmäßig inbegriffen)
Requerido (incluido de serie)
- Necessaria (non inclusa)
Necessary (not included)
Nécessaire (non comprise)
Erforderlich (nicht inbegriffen)
Requerido (no incluido)

COMPATIBILITÀ - COMPATIBILITY - COMPATIBILITÉ - KOMPATIBILITÄT - COMPATIBILIDAD

Installazione a parete da esterno - Wall mounting - Installation murale - Wandmontage - Instalación a pared

Installazione a bordo unità - On board unit installation - Installation embarquée - Installation auf dem Gerät - Instalación al bordo de la unidad

Installazione a parete da incasso - Wall flush-mounting - Installation à encaissement - Wandeinbau - Instalación empotrada

REGOLATORI - CONTROLLERS - RÉGULATEURS - REGLER - REGULADORES

UTILIZZO - USE - UTILISATION - VERWENDUNG - USO

Impianto a 2 tubi - 2 pipe system - Système à 2 tubes - Anlage mit 2 Leiter-System - Sistema de 2 tubos

Impianto a 4 tubi - 4 pipe system - Système à 4 tubes - Anlage mit 4 Leiter-System - Sistema de 4 tubos

CONTROLLI E DISPLAY - CONTROLS & DISPLAY - CONTRÔLES ET ÉCRAN - STEUERUNGEN UND DISPLAY - CONTROLES Y PANTALLAS

Display - Display - Écran - Display - Monitor

Acceso/Spento - On/Off - Allumé/Éteint - Eingeschaltet/Ausgeschaltet - Encendido /Apagado

Caldo/Freddo - Heat/Cool - Chaud/Froid - Heizen/Kühlen - Frío /Caliente

3 velocità ventilatore - 3 fan speed - 3 vitesses ventilateur - 3 Gebläsegeschwindigkeiten - 3 velocidades de ventilador

Regolazione temperatura - Set point range - Réglage température - Temperaturregelung - Regulación de la temperatura

COMMUTAZIONE - CHANGEOVER - COMMUTATION - UMSCHALTUNG - TRASPUESTA

Velocità automatica - Automatic speed control - Vitesse automatique - Automatische Geschwindigkeitseinstellung - Velocidad automática

Caldo/freddo centralizzata - Central season changeover - Chaud/froid centralisé - Heizen/Kühlen Umschaltung - Cambio Verano / Invierno centralizado

Caldo/freddo automatico (impianto 2 tubi) - Automatic season changeover (2 pipe system) - Chaud/froid automatique (système à 2 tubes) Heizen/Kühlen Umschaltung automatisch (Anlage mit 2 Leitersystem) - Cambio automático Verano / Invierno (sistema de 2 tubos)

Caldo/freddo automatico con zona neutra (imp. 4 tubi) - Automatic season changeover with neutral zone (4 pipe syst.) - Chaud/froid automatique avec zone neutre (syst. à 4 tubes) - Heizen/Kühlen Umschaltung automatisch mit neutralem Bereich (Anlage mit 4 Leiter-System) - Cambio automático Verano/Invierno con zona neutra (sist. de 4 tubos)

INGRESSI - INPUTS - ENTRÉES - EINGÄNGE - ENTRADAS

Sonda aria remota - Remote air intake sensor - Capteur air à distance - Lufteintrittsfühler - Sonda de aire remota

Sonda acqua - Water sensor - Capteur eau - Wassertemperaturfühler - Sonda de agua

[TC/TC-B] Termostato di consenso - Low temperature thermostat - Thermostat d'autorisation - Freigabethermostat - Termostato de mínima

Contatto finestra - Windows contact - Contact fenêtre - Fensterkontakt - Contacto de ventana

USCITE - OUTPUTS - SORTIES - AUSGÄNGE - SALIDAS

Valvole On/Off - On/Off valves - Vannes On/Off - Ein-Aus-Ventil - Válvulas On/Off

Valvole 3 punti (PWM) - Floating valves (PWM) - Vannes 3 points (PWM) - 3-Punkt-Ventil (PWM) - Válvulas de 3 puntos (PWM)

Valvole 0-10V - 0-10V proportional valves - Vannes 0-10V - Ventile 0-10 V - Válvulas 0-10V

FUNZIONI SPECIALI - SPECIAL FUNCTIONS - FONCTION SPÉCIALES - SONDERFUNKTIONEN - FUNCIONES ESPECIALES

Ventilatore termostato - Fan thermostat controlled - Ventilateur thermostaté - Thermostatgesteuerter Ventilator - Ventilador termostático

Comando resistenza elettrica - Electric heater control - Commande résistance électrique - Steuerung Elektroheizregister - Control de resistencia eléctrica

Funzione economy - Economy function - Fonction economy - Economy-Funktion - Función Economy

Funzione solo ventilazione - Fan function - Fonction uniquement ventilation - Nur Ventilatorbetrieb - Función sólo ventilador

Timer giornaliero - Daily timer - Minuterie quotidienne - Tagestimer - Temporizador diario

Funzione antistratificazione - Air recirculation function - Fonction anti-stratification - Funktion zum Schutz gegen Schichtbildung - Función anti-estratificación

Funzione Master/Slave - Master/Slave function - Fonction Master/Slave - Master/Slave Funktion - Función Master/Slave

Ventilatore modulante - Modulating fan - Ventilateur modulant - Modulierender Ventilator - Ventilador modulante

Programmazione settimanale - Weekly timetable - Programmation hebdomadaire - Wochenprogrammierung - Programación semanal

[MODbus] Protocollo di comunicazione - Communication protocol - Protocole de communication - Kommunikationsprotokoll - Protocolo de comunicación

[BACnet] Protocollo di comunicazione - Communication protocol - Protocole de communication - Kommunikationsprotokoll - Protocolo de comunicación

Controllo umidità - Humidity control - Contrôle de l'humidité - Feuchtigkeitsregelung - Control humedad

The diagrams, the descriptions and the pictures shown herein are merely indicative and in no way binding. In order to continuously improve and in view of constant research and development, A GROUP S.p.A. reserves the right to modify, also without prior notice, technical data and all the contents included in this document.

Concept and design: Aliseo Group

04/2021



A GROUP S.p.A.

Via Monte Grappa, 67
31020 San Zenone degli Ezzelini (TV) - Italy
Tel. +39 0423 567774 - Fax +39 0423 567985
info@eden-clima.com - www.eden-clima.com
www.aliseogroup.com



Check ongoing validity of certificate:
www.eurovent-certification.com