

EOS

EOS-ECM

Thin profile ductable air treatment unit

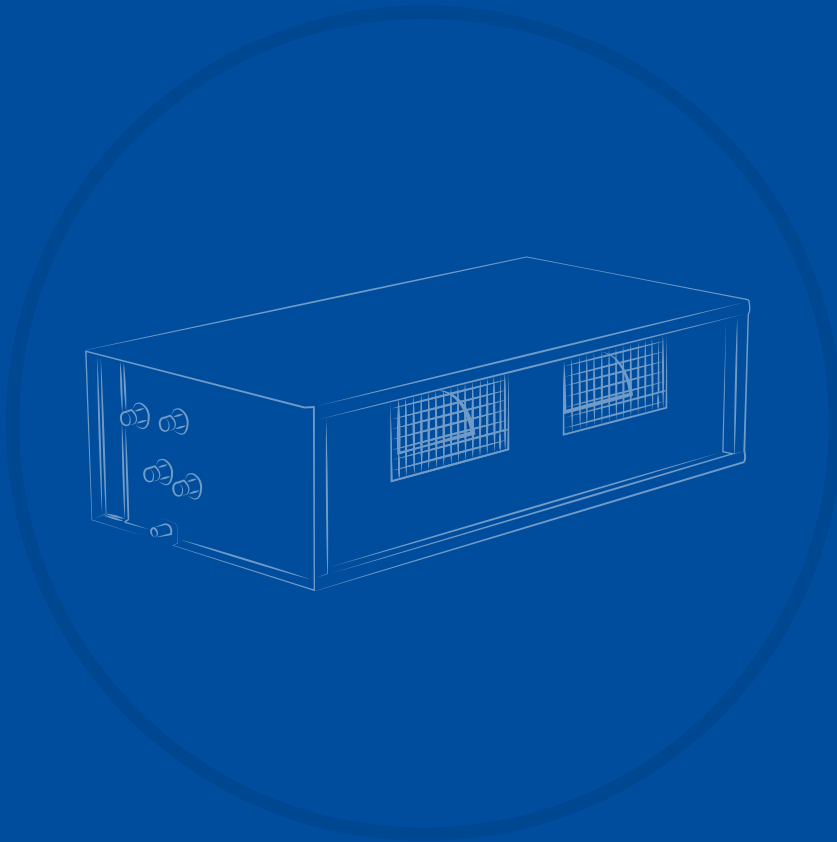

Product Catalog

Rel. 07_02_02_03C_EN

EOS

EOS-ECM

Thin profile
ductable air treatment unit

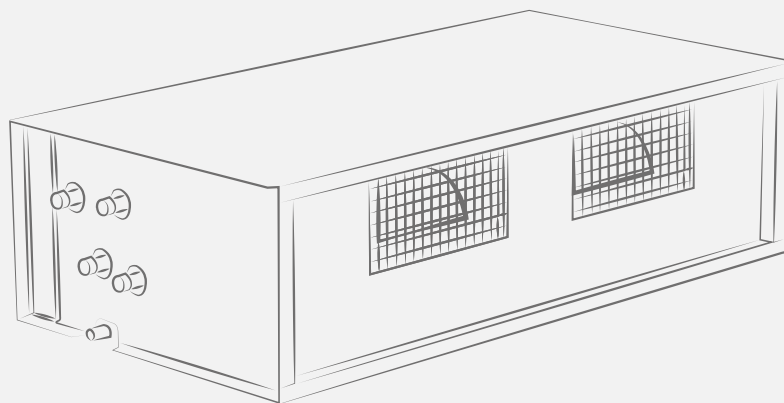

A GROUP S.p.A (Trademark EDEN)
participates in the ECP programme for FCU.
Check ongoing validity of certificate:
www.eurovent-certification.com

Performance and reliability, with maximum efficiency

 **2.4 ÷ 29.6** kW
cooling

 **2.5 ÷ 34.2** kW
heating

 **50%**
energy saving up to 50%

 **353 - 6232** m³/h
air flow



Structure:

single paneling version: made of hot-galvanized sheet Z200 1 mm and 1.5 mm thick (sizes 6-7) insulated with thermo-acoustic mattress class B-s2, d0 with closed cells, 6 mm thick.

double paneling version: made of Z200 hot galvanized sheet 1 mm and 1.5 mm thick (sizes 6-7) pre-painted white RAL9010 externally and internally galvanized, sandwich type panels 15 mm thick with mineral wool thermal and acoustic insulation density 35 kg/m³.



Auxiliary drain pan

made of hot galvanized sheet Z200, 1 mm thick, externally insulated with closed cell thermoacoustic mattress class B-s2, d0, 6 mm thick.



Air filter:

always supplied as standard and integrated in the unit, easily removable from the side or from the bottom, regenerable and made of synthetic filter fabric enclosed by a galvanized steel frame and efficiency class G3 * / EU3 **, 12 mm thick.

Alternatively, a wide range of filters with higher efficiencies are available including G3 * / EU3 ** 25 mm, G4 * / EU4 ** 48 mm or filter with aluminum mesh G1 * / EU1 ** 12 mm. Also available is the innovative electronic filter that allows complete air purification and at the same time ensures high efficiency thanks to minimal pressure drops.

(* according to EN779 / ** according to Eurovent)



Fan group

double-inlet centrifugal fans with statically and dynamically balanced horizontally-oriented aluminium impellers. Single-phase asynchronous electric motor with overload cutout. Multi-speed motor (3 of which are connected). The motor is directly coupled to the fans and cushioned with flexible mountings to ensure low noise.

The ECM series is instead equipped with innovative Brushless ECM motors that guarantee precise and modular control of the air flow, limiting the energy supply to the actual workload required, without unnecessary waste.



Coils:

coils are made of copper pipe expanded into aluminium fins.

Copper headers with male fittings (GAS threads) and easily accessible air vents.

The water connections are located on the left (looking at the air outlet).

On request, the water connections can be placed on the right side of the unit.

The heat exchanger coil is not suitable for use in corrosive atmospheres.

Thin profile ductable air treatment units are available in 8 versions and 7 sizes.

Units are extremely suitable for small and medium centralized conditioning systems connected by a small ducting network. The thin height of these units, make them the convenient solution for false ceiling installation, to make the best use of space available.

Great attention was also paid to the reduction and simplification of maintenance times, allowing the removal of the filter both from the sides and from the bottom.

Versions	
EOS-H	single skin unit, horizontal installation, asynchronous motor
EOS-H-ECM	single skin unit, horizontal installation, ECM motor
EOS-V	single skin unit, vertical installation, asynchronous motor
EOS-V-ECM	single skin unit, vertical installation, ECM motor
EOS-DS-H	double skin unit, horizontal installation, asynchronous motor
EOS-DS-H-ECM	double skin unit, horizontal installation, ECM motor
EOS-DS-V	double skin unit, vertical installation, asynchronous motor
EOS-DS-ECM	double skin unit, vertical installation, ECM motor

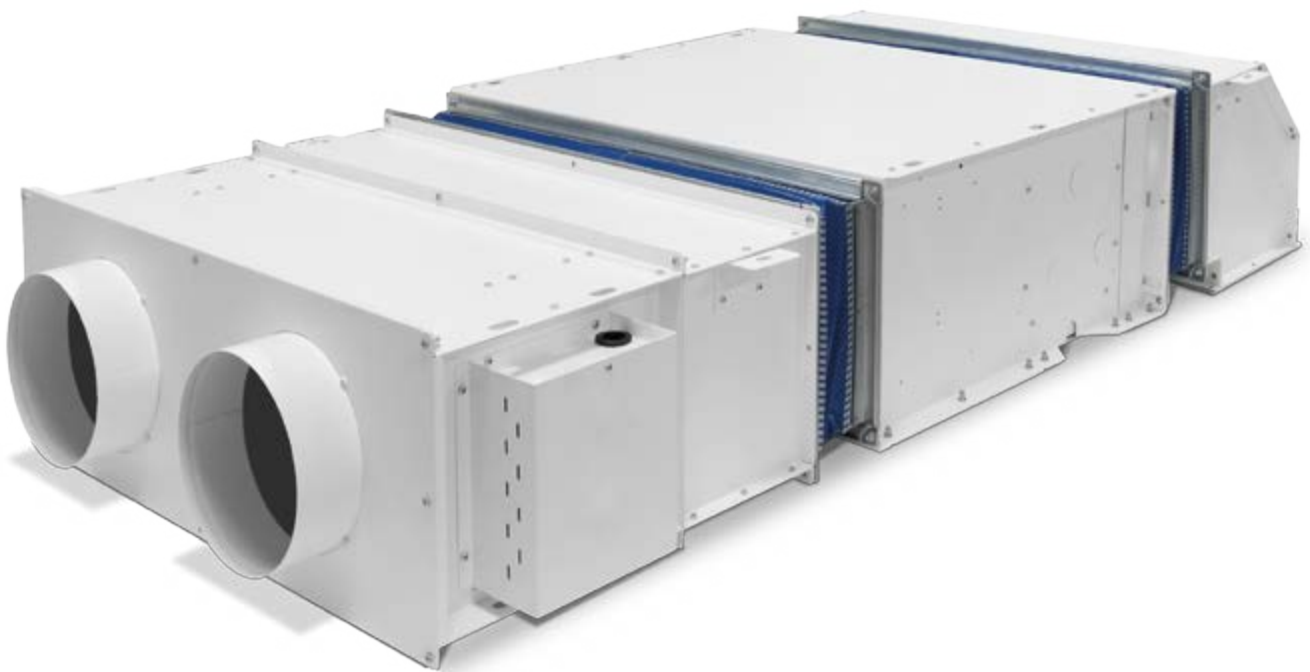

SINGLE SKIN UNIT

H

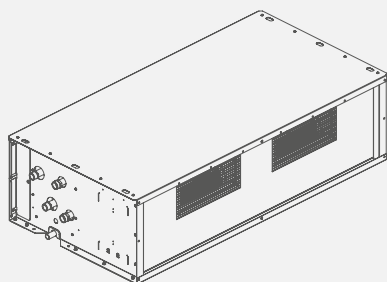

Horizontal installation
Single skin unit
galvanized steel sheet

V

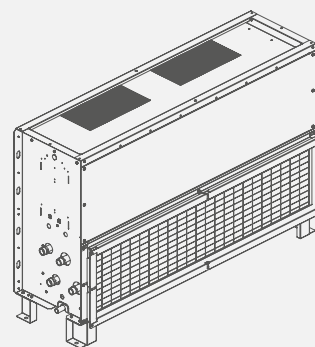

Vertical installation
Single skin unit
galvanized steel sheet

DOUBLE SKIN UNIT

DS-H

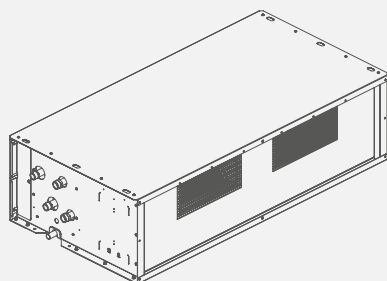

Horizontal installation
Double skin unit
in pre-painted galvanized steel outside
in galvanized steel inside

DS-V

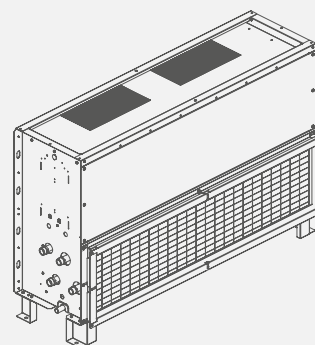

Vertical installation
Double skin unit
in pre-painted galvanized steel outside
in galvanized steel inside

			MOD. H							MOD. DS-H						
Unità orizzontale / Horizontal unit Unité horizontale / Horizontales gerät / Unidad horizontal			1	2	3	4	5	6	7	1	2	3	4	5	6	7
Lunghezza / Length / Longueur / Länge / Longitud	L	mm	770	1070	1270	1420	1520	2190	2190	793	1093	1293	1443	1543	2213	2213
Altezza / Height / Hauteur / Höhe / Altura	H	mm	297	297	347	372	397	373	398	325	325	375	400	425	401	426
Profondità / Depth / Profondeur / Tiefe / Profundidad	P	mm	643	643	643	770	770	770	770	643	643	643	770	770	770	770
	A		38	38	38	38	38	38	38	38	38	38	38	38	38	38
Motori-Ventilatori / Motors-Fans / Moteurs-Ventilateur Motoren-Ventilatoren / Motores-Ventiladores		n°	1-1	1-2	1-2	1-2	1-2	2-4	2-4	1-1	1-2	1-2	1-2	1-2	2-4	2-4

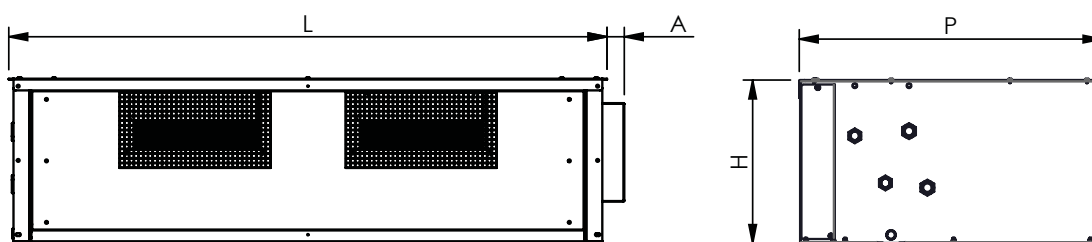

			MOD. V							MOD. DS-V						
Unità verticale / Vertical unit Unité verticale / Vertikales gerät / Unidad vertical			1	2	3	4	5	6	7	1	2	3	4	5	6	7
Lunghezza / Length / Longueur / Länge / Longitud	L	mm	770	1070	1270	1420	1520	2190	2190	793	1093	1293	1443	1543	2213	2213
Altezza / Height / Hauteur / Höhe / Altura	H	mm	740	740	815	890	915	891	916	754	754	829	904	929	905	930
Profondità / Depth / Profondeur / Tiefe / Profundidad	P	mm	297	297	347	372	397	373	398	325	325	375	400	425	401	426
	A		38	38	38	38	38	38	38	38	38	38	38	38	38	38
Motori-Ventilatori / Motors-Fans / Moteurs-Ventilateur Motoren-Ventilatoren / Motores-Ventiladores		n°	1-1	1-2	1-2	1-2	1-2	2-4	2-4	1-1	1-2	1-2	1-2	1-2	2-4	2-4
Filtro / Filter / Filtre / Filter / Filtro	S	mm	52	52	52	52	52	86	86	52	52	52	52	52	86	86

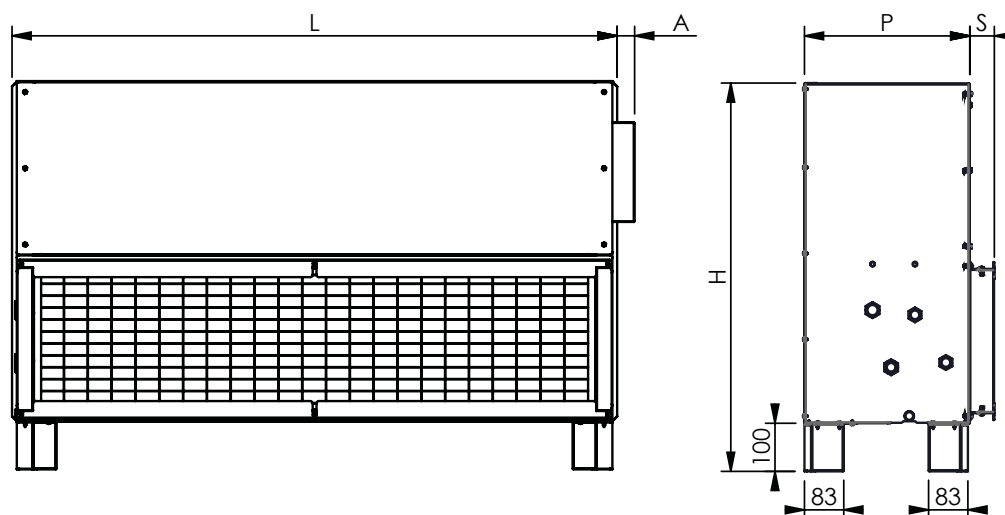

2 tubi - pipes - tubes Leiter - tubos		4R scambiatore - coil - batterie Wärmetauscher - batería		1	2	3	4	5	6 (*)	7 (*)	
7/12 °C 27 °C d.b. 19 °C w.b.	Potenza frigorifera totale Total cooling capacity Puissance frigorifique totale Kälteleistung gesamt Potencia frigorífica total	(E)	W 6	3058	-	-	-	-	-	-	-
			W 5	2987	6358	9708	12565	-	26062	-	
			W 4	2856	6058	9016	12010	16014	24480	29589	
			W 3	2785	5924	7825	11274	15131	22568	27851	
			W 2	2581	5618	6966	9140	13329	17979	24818	
			W 1	2433	5193	5689	6630	11810	13261	22020	
	Potenza frigorifera sensibile Sensible cooling capacity Puissance frigorifique sensible Sensible Kälteleistung Potencia frigorífica total sensible	(E)	W 6	2312	-	-	-	-	-	-	-
			W 5	2256	4618	7048	9145	-	19562	-	
			W 4	2147	4388	6506	8720	11784	18260	22249	
			W 3	2092	4284	5585	8144	11081	16688	20801	
			W 2	1926	4048	4926	6490	9649	13039	18308	
			W 1	1819	3723	3999	4640	8470	9411	16050	
	Portata acqua Water flow Débit d'eau Wassermenge Flujo de agua	(E)	l/h 6	545	-	-	-	-	-	-	-
			l/h 5	530	1122	1714	2236	-	4646	-	
			l/h 4	506	1065	1590	2127	2859	4348	5298	
			l/h 3	493	1041	1380	1994	2695	4003	4976	
			l/h 2	457	988	1229	1614	2373	3182	4430	
			l/h 1	431	914	1003	1171	2103	2344	3931	
Perdite di carico lato acqua Water pressure drop Pertes charge côté eau Wasserseitiger Druckverlust Caidas de presión lado agua	(E)	kPa 6	11,4	-	-	-	-	-	-	-	
		kPa 5	10,8	16,0	20,8	22,0	-	23,7	-		
		kPa 4	9,9	14,6	18,6	20,2	22,8	21,1	32,0		
		kPa 3	9,2	14,1	14,5	18,0	21,0	18,2	28,9		
		kPa 2	8,3	12,8	11,8	12,4	16,8	12,1	22,8		
		kPa 1	7,8	11,2	8,4	7,0	13,6	7,1	18,1		
45/40 °C 20 °C	Potenza termica Heating capacity Puissance thermique Heizleistung Energía térmica	(E)	W 6	3230	-	-	-	-	-	-	
			W 5	3140	6950	10510	13880	-	30200	-	
			W 4	2980	6570	9630	13140	17980	28020	34170	
			W 3	2900	6410	8310	12240	16840	25540	31820	
			W 2	2700	6050	7350	9740	14640	19840	27930	
			W 1	2520	5570	5880	6880	12840	14310	24450	
	Portata acqua Water flow Débit d'eau Wassermenge Flujo de agua	(E)	l/h 6	562	-	-	-	-	-	-	-
			l/h 5	547	1211	1830	2419	-	5261	-	
			l/h 4	519	1144	1686	2289	3132	4881	5952	
			l/h 3	506	1116	1447	2131	2934	4449	5544	
Perdite di carico lato acqua Water pressure drop Pertes charge côté eau Wasserseitiger Druckverlust Caidas de presión lado agua	(E)	l/h 2	470	1054	1280	1696	2550	3454	4865		
		l/h 1	440	970	1024	1201	2236	2492	4261		
		kPa 6	10,1	-	-	-	-	-	-		
		kPa 5	9,9	15,2	19,8	20,8	-	24,3	-		
		kPa 4	9,0	13,8	17,0	18,9	22,6	21,3	32,4		
		kPa 3	8,4	13,2	13,1	17,0	20,2	18,1	28,6		
20 °C 20 °C	Potenza termica Heating capacity Puissance thermique Heizleistung Energía térmica	(E)	W 6	3860	-	-	-	-	-	-	
			W 5	3760	8280	12530	16540	-	35740	-	
			W 4	3570	7830	11560	15660	21370	33210	40470	
			W 3	3480	7640	9930	14600	20030	30310	37740	
			W 2	3240	7220	8790	11640	17440	23620	33190	
			W 1	3030	6650	7050	8260	15330	17090	29110	
	Portata acqua Water flow Débit d'eau Wassermenge Flujo de agua	(E)	l/h 6	545	-	-	-	-	-	-	-
			l/h 5	530	1122	1714	2236	-	4646	-	
			l/h 4	506	1065	1590	2127	2859	4348	5298	
			l/h 3	493	1041	1380	1994	2695	4003	4976	
Perdite di carico lato acqua Water pressure drop Pertes charge côté eau Wasserseitiger Druckverlust Caidas de presión lado agua	(E)	l/h 2	457	988	1229	1614	2373	3182	4430		
		l/h 1	431	914	1003	1171	2103	2344	3931		
		kPa 6	9,4	-	-	-	-	-	-		
		kPa 5	9,2	13,1	17,3	17,9	-	19,3	-		
		kPa 4	8,3	11,9	15,2	16,4	18,9	17,1	25,9		
		kPa 3	7,9	11,5	11,8	14,6	17,1	14,8	23,2		
Portata acqua Water flow Débit d'eau Wassermenge Flujo de agua	(E)	kPa 2	6,7	10,4	9,6	10,1	13,6	9,9	18,9		
		kPa 1	6,2	9,1	6,7	5,7	11,0	5,8	15,3		

* Unità non soggette a certificazione Eurovent per limiti di definizione - Units not subject to Eurovent certification due to definition limits - Unités non soumises à la certification Eurovent par liôtes de définition
Geräte, die aufgrund von Definitionsgrenzen nicht der Eurovent-Zertifizierung unterliegen - Unidades no sujetas a certificación Eurovent debido a criterios de medida

- Il test per la rilevazione del livello di potenza sonora è stato eseguito in accordo con la normativa EN 16583:2015 / Livello di pressione sonora: considerata 8,6 dB(A) inferiore rispetto alla potenza sonora in una stanza di 90 m³ con un tempo di riverbero di 0,5 sec. / Valori tensione ammissibile: ~230V / 1ph / 50-60Hz
- The sound power level test has been performed according to EN 16583:2015 standard / Sound pressure level: 8,6 dB(A) lower than the sound power level for a room of 90 m³ with a reverberation time of 0,5 sec. / Supported power supply: ~230V / 1ph / 50-60Hz
- Le test de détection du niveau de puissance acoustique a été réalisé conformément à la norme EN 16583: 2015 / Niveau de pression sonore: considéré de 8,6 dB(A) plus faible que le niveau de puissance acoustique d'une pièce de 90 m³, avec un temps de réverbération de 0,5 sec. / Valeurs de tension admissibles: ~230V / 1ph / 50-60Hz
- Der Test zur Erfassung des Schalleistungspegels wurde gemäß der Norm EN 16583: 2015 durchgeführt / Schall-Druckpegel: Schall-Druckpegel: 8,6 dB (A) unter dem Schalldruck in einem Raum von 90 m³ mit einer Nachhallzeit von 0,5 s. / Unterstützte Stromversorgung: ~230V / 1ph / 50-60Hz
- La prueba de nivel acústico se realizó de acuerdo con la norma EN 16583:2015 / Nivel de presión sonora: se considera 8,6 dB (A) inferior a la potencia acústica en una sala de 90 m³ con un tiempo de reverberación de 0,5 seg. / Valores de voltaje admisibles: ~230V / 1ph / 50-60Hz

velocità cablate / wired speed / vitesse câblée / verkabelte Geschwindigkeitsstufe / velocidades cableadas (E) = Eurovent

2 tubi - pipes - tubes Leiter - tubos		4R scambiatore - coil - batterie Wärmetauscher - batería		1	2	3	4	5	6 (*)	7 (*)
Portata aria Air flow Débit d'air Luftstrom Flujo de aire	(E)	m³/h	6	534	-	-	-	-	-	-
		m³/h	5	516	1114	1693	2286	-	5429	-
		m³/h	4	484	1039	1528	2128	3052	4916	6232
		m³/h	3	469	1007	1267	1946	2806	4357	5668
		m³/h	2	381	939	1092	1470	2349	3161	4776
		m³/h	1	353	848	838	976	1997	2122	4027
Pressione statica Static pressure Pression statique Statischer Druck Presión estática	(E)	Pa	6	61	-	-	-	-	-	-
		Pa	5	57	63	90	124	-	77	-
		Pa	4	50	55	73	106	86	63	86
		Pa	3	46	50	50	88	72	50	72
		Pa	2	39	44	37	50	50	26	50
		Pa	1	33	36	22	22	37	11	37
Livello di potenza sonora aspirazione + radiata / Sound power level inlet + radiated / Niveaux de puissance acoustique aspiration + rayonné / Schalleistungspegel Austritt und Abgestrahlt / Nivel de potencia acústica de admisión + resonancia	(E)	dB(A)	6	63	-	-	-	-	-	-
		dB(A)	5	62	71	65	70	-	73	-
		dB(A)	4	60	68	63	68	73	72	76
		dB(A)	3	59	67	59	64	70	69	74
		dB(A)	2	56	67	55	58	67	61	70
		dB(A)	1	54	63	51	55	63	55	66
Livello di potenza sonora mandata Sound power level outlet Niveaux de puissance acoustique soufflage Schalleistungspegel Austritt Nivel de potencia sonora de salida	(E)	dB(A)	6	62	-	-	-	-	-	-
		dB(A)	5	61	67	69	74	-	76	-
		dB(A)	4	59	65	66	70	75	74	78
		dB(A)	3	58	64	60	66	71	70	75
		dB(A)	2	55	64	57	59	66	61	69
		dB(A)	1	52	60	50	56	62	55	65
Livello di pressione sonora aspirazione + radiata / Sound pressure level inlet + radiated / Niveau de pression acoustique aspiration + rayonné / Schalldruckpegel Eintritt und Abgestrahlt / Nivel de presión sonora de admisión + resonancia	(E)	dB(A)	6	54	-	-	-	-	-	-
		dB(A)	5	53	62	56	61	-	64	-
		dB(A)	4	51	59	54	59	64	63	67
		dB(A)	3	50	58	50	55	61	60	65
		dB(A)	2	47	58	46	49	58	52	61
		dB(A)	1	45	54	42	46	54	46	57
Livello di pressione sonora mandata Sound pressure level outlet Niveau de pression acoustique soufflage Schallleistungspegel Austritt Nivel de presión sonora de salida	(E)	dB(A)	6	53	-	-	-	-	-	-
		dB(A)	5	52	58	60	65	-	67	-
		dB(A)	4	50	56	57	61	66	65	69
		dB(A)	3	49	55	51	57	62	61	66
		dB(A)	2	46	55	48	50	57	52	60
		dB(A)	1	43	51	41	47	53	46	56
Livello di potenza sonora aspirazione + radiata / Sound power level inlet + radiated / Niveaux de puissance acoustique aspiration + rayonné / Schalleistungspegel Austritt und Abgestrahlt / Nivel de potencia acústica de admisión + resonancia	(E)	dB(A)	6	62	-	-	-	-	-	-
		dB(A)	5	61	70	64	69	-	72	-
		dB(A)	4	59	67	62	67	72	71	75
		dB(A)	3	58	66	58	64	69	68	73
		dB(A)	2	55	66	54	57	66	60	69
		dB(A)	1	53	62	50	54	62	54	65
Livello di potenza sonora mandata Sound power level outlet Niveaux de puissance acoustique soufflage Schalleistungspegel Austritt Nivel de potencia sonora de salida	(E)	dB(A)	6	61	-	-	-	-	-	-
		dB(A)	5	60	66	68	73	-	75	-
		dB(A)	4	58	64	65	69	74	73	77
		dB(A)	3	57	63	59	65	70	69	74
		dB(A)	2	54	63	56	58	65	60	68
		dB(A)	1	51	59	49	55	61	54	64
Livello di pressione sonora aspirazione + radiata / Sound pressure level inlet + radiated / Niveau de pression acoustique aspiration + rayonné / Schalldruckpegel Eintritt und Abgestrahlt / Nivel de presión sonora de admisión + resonancia	(E)	dB(A)	6	53	-	-	-	-	-	-
		dB(A)	5	52	61	55	60	-	63	-
		dB(A)	4	50	58	53	58	63	62	66
		dB(A)	3	49	57	49	55	60	59	64
		dB(A)	2	46	57	45	48	57	51	60
		dB(A)	1	44	53	41	45	53	45	56
Livello di pressione sonora mandata Sound pressure level outlet Niveau de pression acoustique soufflage Schallleistungspegel Austritt Nivel de presión sonora de salida	(E)	dB(A)	6	52	-	-	-	-	-	-
		dB(A)	5	51	57	59	64	-	66	-
		dB(A)	4	49	55	56	60	65	64	68
		dB(A)	3	48	54	50	56	61	60	65
		dB(A)	2	45	54	47	49	56	51	59
		dB(A)	1	42	50	40	46	52	45	55

* Unità non soggette a certificazione Eurovent per limiti di definizione - Units not subject to Eurovent certification due to definition limits - Unités non soumises à la certification Eurovent par limites de définition
Geräte, die aufgrund von Definitionsgrenzen nicht der Eurovent-Zertifizierung unterliegen - Unidades no sujetas a certificación Eurovent debido a criterios de medida

- Il test per la rilevazione del livello di potenza sonora è stato eseguito in accordo con la **normativa EN 16583:2015 / Livello di pressione sonora**: considerata 8,6 dB(A) inferiore rispetto alla potenza sonora in una stanza di 90 m³ con un tempo di riverbero di 0,5 sec. / **Valori tensione ammissibile**: ~230V / 1ph / 50-60Hz
- The sound power level test has been performed according to **EN 16583:2015 standard / Sound pressure level**: 8,6 dB(A) lower that the sound power level for a room of 90 m³ with a reverberation time of 0,5 sec. / **Supported power supply**: ~230V / 1ph / 50-60Hz
- Le test de détection du niveau de puissance acoustique a été réalisé conformément à la norme EN 16583: 2015 / **Niveau de pression sonore**: considéré de 8,6 dB(A) plus faible que le niveau de puissance acoustique d'une pièce de 90 m³, avec un temps de réverbération de 0,5 sec. / **Valores de tension admisibles**: ~230V / 1ph / 50-60Hz
- Der Test zur Erfassung des Schalleistungspegels wurde gemäß der Norm EN 16583: 2015 durchgeführt / **Schall-Druckpegel**: Schall-Druckpegel: 8,6 dB (A) unter dem Schalldruck in einem Raum von 90 m³ mit einer Nachhallzeit von 0,5 s. / **Unterstützte Stromversorgung**: ~230V / 1ph / 50-60Hz
- La prueba de nivel acústico se realizó de acuerdo con la **norma EN 16583:2015 / Nivel de presión sonora**: se considera 8,6 dB (A) inferior a la potencia acústica en una sala de 90 m³ con un tiempo de reverberación de 0,5 seg. / **Valores de voltaje admisibles**: ~230V / 1ph / 50-60Hz

velocità cablate / wired speed / vitesse câblée / verkabelte Geschwindigkeitsstufe / velocidades cableadas (E) = Eurovent

4 tubi - pipes - tubes (4+2)R scambiatore - coil - batterie Leiter - tubos Wärmetauscher - batería			1	2	3	4	5	6 (*)	7 (*)
7/12°C 27°C d.b. 19°C w.b.	Potenza frigorifera totale Total cooling capacity Puissance frigorifique totale Kälteleistung gesamt Potencia frigorífica total	(E) W 6	3101	-	-	-	-	-	-
		(E) W 5	3010	5968	9338	11937	-	24582	-
		(E) W 4	2896	5728	8786	11521	15214	23350	27349
		(E) W 3	2837	5634	7725	10924	14511	21768	26171
		(E) W 2	2662	5408	6896	8970	13009	17549	23958
		(E) W 1	2516	5073	5639	6550	11620	12931	21520
	Potenza frigorifera sensibile Sensible cooling capacity Puissance frigorifique sensible Sensible Kälteleistung Potencia frigorífica total sensible	(E) W 6	2182	-	-	-	-	-	-
		(E) W 5	2136	4318	6758	8647	-	18322	-
		(E) W 4	2047	4138	6326	8331	11134	17320	20369
		(E) W 3	2002	4064	5505	7864	10581	16038	19401
		(E) W 2	1876	3888	4876	6370	9389	12689	17608
		(E) W 1	1769	3633	3959	4590	8320	9151	15650
	Portata acqua Water flow Débit d'eau Wassermenge Flujo de agua	(E) l/h 6	552	-	-	-	-	-	-
		(E) l/h 5	536	1055	1651	2129	-	4406	-
		(E) l/h 4	513	1009	1551	2044	2721	4167	4912
		(E) l/h 3	502	991	1363	1934	2589	3878	4687
		(E) l/h 2	471	952	1217	1586	2318	3117	4282
		(E) l/h 1	445	893	995	1158	2071	2294	3845
Perdite di carico lato acqua Water pressure drop Pertes charge côté eau Wasserseitiger Druckverlust Caidas de presión lado agua	(E) kPa 6	10,2	-	-	-	-	-	-	
	(E) kPa 5	9,9	14,4	20,3	20,2	-	21,3	-	
	(E) kPa 4	9,1	13,3	17,8	18,8	21,3	20,2	28,7	
	(E) kPa 3	8,7	12,9	14,2	17,0	19,5	18,4	26,4	
	(E) kPa 2	7,9	12,0	11,6	12,0	16,1	12,1	22,2	
	(E) kPa 1	7,0	10,8	8,2	6,9	13,2	7,4	18,8	
65/55°C 20°C	Potenza termica Heating capacity Puissance thermique Heizleistung Energía térmica	(E) W 6	4180	-	-	-	-	-	
		(E) W 5	4080	7910	12070	15520	-	32950	-
		(E) W 4	3930	7580	11380	14930	19970	31190	35980
		(E) W 3	3860	7460	10070	14170	19040	29080	34360
		(E) W 2	3660	7180	9080	11760	17130	23600	31460
		(E) W 1	3440	6770	7490	8770	15400	17770	28360
	Portata acqua Water flow Débit d'eau Wassermenge Flujo de agua	(E) l/h 6	366	-	-	-	-	-	-
		(E) l/h 5	358	693	1058	1361	-	2888	-
		(E) l/h 4	345	665	997	1309	1751	2735	3155
		(E) l/h 3	338	654	883	1242	1669	2550	3012
		(E) l/h 2	321	630	797	1031	1502	2069	2758
		(E) l/h 1	301	594	657	769	1351	1558	2486
	Perdite di carico lato acqua Water pressure drop Pertes charge côté eau Wasserseitiger Druckverlust Caidas de presión lado agua	(E) kPa 6	13,2	-	-	-	-	-	-
		(E) kPa 5	12,7	17,9	12,7	9,2	-	36,9	-
		(E) kPa 4	11,9	16,6	11,4	8,6	16,6	33,5	24,8
		(E) kPa 3	11,5	16,1	9,2	7,9	15,2	29,6	22,8
		(E) kPa 2	10,5	15,1	7,7	5,7	12,7	20,5	19,6
		(E) kPa 1	9,4	13,6	5,5	3,4	10,5	12,4	16,3
70/60°C 20°C	Potenza termica Heating capacity Puissance thermique Heizleistung Energía térmica	(E) W 6	4710	-	-	-	-	-	
		(E) W 5	4610	8930	13640	17560	-	37220	-
		(E) W 4	4430	8560	12860	16900	22590	35230	40690
		(E) W 3	4350	8420	11380	16030	21520	32840	38850
		(E) W 2	4130	8110	10260	13300	19360	26640	35570
		(E) W 1	3880	7640	8450	9910	17410	20040	32050
	Portata acqua Water flow Débit d'eau Wassermenge Flujo de agua	(E) l/h 6	414	-	-	-	-	-	-
		(E) l/h 5	405	785	1199	1542	-	3269	-
		(E) l/h 4	390	752	1130	1484	1984	3095	3574
		(E) l/h 3	382	740	1000	1408	1890	2885	3413
		(E) l/h 2	362	712	901	1169	1702	2341	3124
		(E) l/h 1	341	671	742	870	1529	1760	2815
	Perdite di carico lato acqua Water pressure drop Pertes charge côté eau Wasserseitiger Druckverlust Caidas de presión lado agua	(E) kPa 6	16,1	-	-	-	-	-	-
		(E) kPa 5	15,5	21,8	15,5	11,3	-	45,0	-
		(E) kPa 4	14,5	20,3	13,9	10,6	20,3	40,8	30,3
		(E) kPa 3	14,0	19,7	11,2	9,6	18,6	36,1	27,9
		(E) kPa 2	12,7	18,4	9,4	6,9	15,5	25,0	23,9
		(E) kPa 1	11,4	16,6	6,7	4,1	12,8	15,1	19,9

* Unità non soggette a certificazione Eurovent per limiti di definizione - Units not subject to Eurovent certification due to definition limits - Unités non soumises à la certification Eurovent par limites de définition
Geräte, die aufgrund von Definitionsgrenzen nicht der Eurovent-Zertifizierung unterliegen - Unidades no sujetas a certificación Eurovent debido a criterios de medida

- Il test per la rilevazione del livello di potenza sonora è stato eseguito in accordo con la normativa EN 16583:2015 / Livello di pressione sonora: considerata 8,6 dB(A) inferiore rispetto alla potenza sonora in una stanza di 90 m³ con un tempo di riverbero di 0,5 sec. / Valori tensione ammissibile: ~230V / 1ph / 50-60Hz
- The sound power level test has been performed according to EN 16583:2015 standard / Sound pressure level: 8,6 dB(A) lower than the sound power level for a room of 90 m³ with a reverberation time of 0,5 sec. / Supported power supply: ~230V / 1ph / 50-60Hz
- Le test de détection du niveau de puissance acoustique a été réalisé conformément à la norme EN 16583: 2015 / Niveau de pression sonore: considéré de 8,6 dB(A) plus faible que le niveau de puissance acoustique d'une pièce de 90 m³, avec un temps de réverbération de 0,5 sec. / Valeurs de tension admissibles: ~230V / 1ph / 50-60Hz
- Der Test zur Erfassung des Schalleistungspegels wurde gemäß der Norm EN 16583: 2015 durchgeführt / Schall-Druckpegel: Schall-Druckpegel: 8,6 dB (A) unter dem Schalldruck in einem Raum von 90 m³ mit einer Nachhallzeit von 0,5 s. / Unterstützte Stromversorgung: ~230V / 1ph / 50-60Hz
- La prueba de nivel acústico se realizó de acuerdo con la norma EN 16583:2015 / Nivel de presión sonora: se considera 8,6 dB (A) inferior a la potencia acústica en una sala de 90 m³ con un tiempo de reverberación de 0,5 seg. / Valores de voltaje admisibles: ~230V / 1ph / 50-60Hz

velocità cablate / wired speed / vitesse câblée / verkabelte Geschwindigkeitsstufe / velocidades cableadas (E) = Eurovent

4 tubi - pipes - tubes (4+2)R scambiatore - coil - batterie Leiter - tubos Wärmetauscher - batería		1	2	3	4	5	6 (*)	7 (*)
Portata aria Air flow Débit d'air Luftstrom Flujo de aire	m³/h 6	499	-	-	-	-	-	-
	m³/h 5	484	1025	1608	2129	-	4991	-
	m³/h 4	459	966	1478	2014	2844	4598	5562
	m³/h 3	447	944	1245	1868	2651	4144	5187
	m³/h 2	369	894	1079	1437	2275	3062	4548
	m³/h 1	344	824	829	963	1956	2059	3904
Pressione statica Static pressure Pression statique Statischer Druck Presión estática	Pa 6	61	-	-	-	-	-	-
	Pa 5	57	63	90	124	-	77	-
	Pa 4	50	55	73	106	86	63	86
	Pa 3	46	50	50	82	72	50	72
	Pa 2	39	44	37	50	50	26	50
	Pa 1	33	36	22	22	37	11	37
Livello di potenza sonora aspirazione + radiata / Sound power level inlet + radiated / Niveaux de puissance acoustique aspiration + rayonné / Schalleistungspegel Austritt und Abgestrahlt / Nivel de potencia acústica de admisión + resonancia	dB(A) 6	63	-	-	-	-	-	-
	dB(A) 5	62	71	65	70	-	73	-
	dB(A) 4	60	68	63	68	72	72	76
	dB(A) 3	59	67	59	68	70	69	74
	dB(A) 2	56	67	55	62	67	61	70
	dB(A) 1	54	63	51	55	63	55	66
Livello di potenza sonora mandata Sound power level outlet Niveaux de puissance acoustique soufflage Schalleistungspegel Austritt Nivel de potencia sonora de salida	dB(A) 6	62	-	-	-	-	-	-
	dB(A) 5	61	67	69	74	-	76	-
	dB(A) 4	59	65	66	70	74	74	78
	dB(A) 3	58	64	60	68	71	70	75
	dB(A) 2	55	64	54	62	66	61	69
	dB(A) 1	52	60	50	56	62	55	65
Livello di pressione sonora aspirazione + radiata / Sound pressure level inlet + radiated / Niveau de pression acoustique aspiration + rayonné / Schalldruckpegel Eintritt und Abgestrahlt / Nivel de presión sonora de admisión + resonancia	dB(A) 6	54	-	-	-	-	-	-
	dB(A) 5	53	62	56	61	-	64	-
	dB(A) 4	51	59	54	59	63	63	67
	dB(A) 3	50	58	50	59	61	60	65
	dB(A) 2	47	58	46	53	58	52	61
	dB(A) 1	45	54	42	46	54	46	57
Livello di pressione sonora mandata Sound pressure level outlet Niveau de pression acoustique soufflage Schalldruckpegel Austritt Nivel de presión sonora de salida	dB(A) 6	53	-	-	-	-	-	-
	dB(A) 5	52	58	60	65	-	67	-
	dB(A) 4	50	56	57	61	65	65	69
	dB(A) 3	49	55	51	59	62	61	66
	dB(A) 2	46	55	45	53	57	52	60
	dB(A) 1	43	51	41	47	53	46	56
Livello di potenza sonora aspirazione + radiata / Sound power level inlet + radiated / Niveaux de puissance acoustique aspiration + rayonné / Schalleistungspegel Austritt und Abgestrahlt / Nivel de potencia acústica de admisión + resonancia	dB(A) 6	62	-	-	-	-	-	-
	dB(A) 5	61	70	64	69	-	72	-
	dB(A) 4	59	67	62	67	71	71	75
	dB(A) 3	58	66	58	65	69	68	73
	dB(A) 2	55	66	54	57	66	60	69
	dB(A) 1	53	62	50	54	62	54	65
Livello di potenza sonora mandata Sound power level outlet Niveaux de puissance acoustique soufflage Schalleistungspegel Austritt Nivel de potencia sonora de salida	dB(A) 6	61	-	-	-	-	-	-
	dB(A) 5	60	66	68	73	-	75	-
	dB(A) 4	58	64	65	69	73	73	77
	dB(A) 3	57	63	59	66	70	69	74
	dB(A) 2	54	63	53	58	65	60	68
	dB(A) 1	51	59	49	55	61	54	64
Livello di pressione sonora aspirazione + radiata / Sound pressure level inlet + radiated / Niveau de pression acoustique aspiration + rayonné / Schalldruckpegel Eintritt und Abgestrahlt / Nivel de presión sonora de admisión + resonancia	dB(A) 6	53	-	-	-	-	-	-
	dB(A) 5	52	61	55	60	-	63	-
	dB(A) 4	50	58	53	58	62	62	66
	dB(A) 3	49	57	49	56	60	59	64
	dB(A) 2	46	57	45	48	57	51	60
	dB(A) 1	44	53	41	45	53	45	56
Livello di pressione sonora mandata Sound pressure level outlet Niveau de pression acoustique soufflage Schalldruckpegel Austritt Nivel de presión sonora de salida	dB(A) 6	52	-	-	-	-	-	-
	dB(A) 5	51	57	59	64	-	66	-
	dB(A) 4	49	55	56	60	64	64	68
	dB(A) 3	48	54	50	57	61	60	65
	dB(A) 2	45	54	44	49	56	51	59
	dB(A) 1	42	50	40	46	52	45	55

* Unità non soggette a certificazione Eurovent per limiti di definizione - Units not subject to Eurovent certification due to definition limits - Unités non soumises à la certification Eurovent par limites de définition
Geräte, die aufgrund von Definitionsgrenzen nicht der Eurovent-Zertifizierung unterliegen - Unidades no sujetas a certificación Eurovent debido a criterios de medida

- Il test per la rilevazione del livello di potenza sonora è stato eseguito in accordo con la **normativa EN 16583:2015 / Livello di pressione sonora**: considerata 8,6 dB(A) inferiore rispetto alla potenza sonora in una stanza di 90 m³ con un tempo di riverbero di 0,5 sec. / **Valori tensione ammissibile**: ~230V / 1ph / 50-60Hz
- The sound power level test has been performed according to **EN 16583:2015 standard / Sound pressure level**: 8,6 dB(A) lower that the sound power level for a room of 90 m³ with a reverberation time of 0,5 sec. / **Supported power supply**: ~230V / 1ph / 50-60Hz
- Le test de détection du niveau de puissance acoustique a été réalisé conformément à la norme **EN 16583:2015 / Niveau de pression sonore**: considéré de 8,6 dB(A) plus faible que le niveau de puissance acoustique d'une pièce de 90 m³, avec un temps de réverbération de 0,5 sec. / **Valores de tension admisibles**: ~230V / 1ph / 50-60Hz
- Der Test zur Erfassung des Schalleistungspegels wurde gemäß der Norm **EN 16583:2015** durchgeführt / **Schall-Druckpegel**: Schall-Druckpegel: 8,6 dB (A) unter dem Schalldruck in einem Raum von 90 m³ mit einer Nachhallzeit von 0,5 s. / **Unterstützte Stromversorgung**: ~230V / 1ph / 50-60Hz
- La prueba de nivel acústico se realizó de acuerdo con la **norma EN 16583:2015 / Nivel de presión sonora**: se considera 8,6 dB (A) inferior a la potencia acústica en una sala de 90 m³ con un tiempo de reverberación de 0,5 seg. / **Valores de voltaje admisibles**: ~230V / 1ph / 50-60Hz

velocità cablate / wired speed / vitesse câblée / verkabelte Geschwindigkeitsstufe / velocidades cableadas (E) = Eurovent

Motore asincrono - Asynchronous motor Moteur asynchrone - Asynchronmotor - Motor asíncrono			1	2	3	4	5	6 (*)	7 (*)
Potenza assorbita dal motore del ventilatore Motor fan absorbed power Puissance absorbée par le moteur de ventilateur Vom Lüftermotor aufgenommene Leistung Potencia absorbida por el motor del ventilador	(E)	W 6	108	-	-	-	-	-	-
		W 5	94	162	252	463	-	1018	-
		W 4	82	149	224	389	596	860	1191
		W 3	78	144	195	346	529	762	1059
		W 2	73	138	174	270	461	561	922
		W 1	71	122	141	200	410	399	820
Corrente assorbita dal motore del ventilatore Motor fan absorbed current Courant absorbé par le moteur du ventilateur Vom Lüftermotor aufgenommener Strom Corriente absorbida por el motor del ventilador		A 6	0,52	-	-	-	-	-	-
		A 5	0,45	0,78	1,22	2,24	-	4,92	-
		A 4	0,4	0,72	1,08	1,88	2,88	4,15	5,76
		A 3	0,38	0,70	0,94	1,67	2,56	3,68	5,11
		A 2	0,35	0,67	0,84	1,29	2,23	2,71	4,46
		A 1	0,34	0,58	0,68	0,95	1,98	1,93	3,96
Tensione di alimentazione Power supply Tension d'alimentation Stromversorgung Tensión de alimentación			~230V / 1ph / 50-60Hz						

* Unità non soggette a certificazione Eurovent per limiti di definizione - Units not subject to Eurovent certification due to definition limits - Unités non soumises à la certification Eurovent par liôtes de définition
Geräte, die aufgrund von Definitionsgrenzen nicht der Eurovent-Zertifizierung unterliegen - Unidades no sujetas a certificación Eurovent debido a criterios de medida

velocità cablate / wired speed / vitesse câblée / verkabelte Geschwindigkeitsstufe / velocidades cableadas (E) = Eurovent

Motore ECM - ECM motor Moteur ECM - ECM-Motor - Motor ECM			1	2	3	4	5	6 (*)	7 (*)
Potenza assorbita dal motore del ventilatore Motor fan absorbed power Puissance absorbée par le moteur de ventilateur Vom Lüftermotor aufgenommene Leistung Potencia absorbida por el motor del ventilador	(E)	W 6	75	-	-	-	-	-	-
		W 5	69	131	207	343	-	829	-
		W 4	58	109	156	305	490	632	1043
		W 3	53	99	95	240	379	458	790
		W 2	35	82	66	115	232	203	478
		W 1	29	64	37	45	158	87	309
Corrente assorbita dal motore del ventilatore Motor fan absorbed current Courant absorbé par le moteur du ventilateur Vom Lüftermotor aufgenommener Strom Corriente absorbida por el motor del ventilador		A 6	0,65	-	-	-	-	-	-
		A 5	0,61	1,02	1,78	2,70	-	6,60	-
		A 4	0,51	0,84	1,16	1,75	2,59	3,81	5,57
		A 3	0,43	0,77	0,67	1,14	1,93	2,24	4,04
		A 2	0,26	0,66	0,48	0,56	1,05	0,93	2,16
		A 1	0,24	0,48	0,28	0,21	0,68	0,39	1,34
Tensione di controllo velocità (Vcc) Speed control voltage (Vdc) Tension de contrôle de vitesse (Vcc) Drehzahlregelspannung (Vcc) Voltaje de control de velocidad (Vcc)		V 6	7,4	-	-	-	-	-	-
		V 5	6,8	9,4	8,1	9,7	-	9,0	-
		V 4	5,9	8,2	7,1	8,2	7,3	7,5	7,5
		V 3	5,4	7,6	5,5	7,1	6,5	6,4	6,6
		V 2	3,8	6,7	4,5	4,6	5,2	4,1	5,2
		V 1	2,7	5,2	2,6	2,1	4,3	1,5	4,3
Tensione di alimentazione Power supply Tension d'alimentation Stromversorgung Tensión de alimentación			~230V / 1ph / 50-60Hz						

* Unità non soggette a certificazione Eurovent per limiti di definizione - Units not subject to Eurovent certification due to definition limits - Unités non soumises à la certification Eurovent par liôtes de définition
Geräte, die aufgrund von Definitionsgrenzen nicht der Eurovent-Zertifizierung unterliegen - Unidades no sujetas a certificación Eurovent debido a criterios de medida

velocità cablate / wired speed / vitesse câblée / verkabelte Geschwindigkeitsstufe / velocidades cableadas (E) = Eurovent

Weights and packaging

SINGLE SKIN UNIT

	dimensioni	peso netto	peso lordo	bancale		
	dimension	net weight	gross weight	L x P [mm]	[n.] unità - units	[kg] tot.
	[mm] (AxBxC)	[kg]	[kg]			
MOD. H 1	840 x 673 x 307	29	31	1200 x 800	5	170
MOD. H 2	1140 x 673 x 307	40	42	1200 x 800	5	225
MOD. H 3	1340 x 673 x 357	51	53	1550 x 800	5	280
MOD. H 4	1490 x 800 x 382	65	67	1550 x 800	5	350
MOD. H 5	1590 x 800 x 407	76	78	1800 x 900	4	327
MOD. H 6	2260 x 800 x 390	133	133	2400 x 800	4	547
MOD. H 7	2260 x 800 x 410	141	141	2400 x 800	4	579

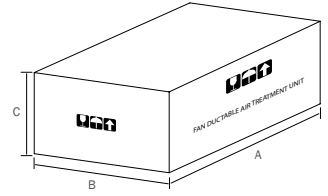

DOUBLE SKIN UNIT

	dimensioni	peso netto	peso lordo	bancale		
	dimension	net weight	gross weight	L x P [mm]	[n.] unità - units	[kg] tot.
	[mm] (AxBxC)	[kg]	[kg]			
MOD. DS H 1	840 x 650 x 330	43	45	1200 x 800	5	240
MOD. DS H 2	1440 x 650 x 330	59	61	1200 x 800	5	320
MOD. DS H 3	1340 x 650 x 380	71	73	1550 x 800	5	380
MOD. DS H 4	1490 x 800 x 420	92	94	1550 x 800	5	485
MOD. DS H 5	1590 x 800 x 440	101	103	1800 x 900	4	427
MOD. DS H 6	2260 x 800 x 420	167	167	2400 x 800	4	683
MOD. DS H 7	2260 x 800 x 440	175	175	2400 x 800	4	715

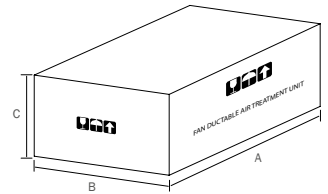

Independent balancing valve

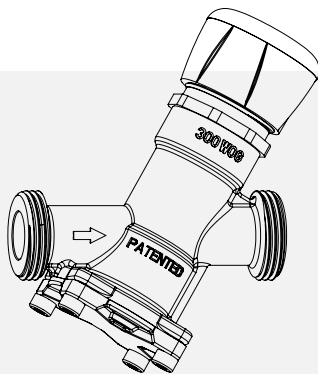

This type of valve combines two functions in a single valve, keeps the flow rate constant as the system pressure changes and at the same time regulates the flow according to the temperature, allowing perfect balancing of the hydraulic system, ensuring for each fan coil unit the desired water flow even under partial loads.

The adjustment can be performed automatically through the installation of a linear ON / OFF or modulating actuator.

Main advantages:

- Simplified selection
- Easy installation
- High valve authority which remains constant
- Constant flow rate as the differential pressure changes
- Optimized installation by measuring the set pressure
- Energy efficiency thanks to the low differential pressure required
- Maintenance of the set water flow even at partial loads
- Optimization of pump speed using pressure taps (optional)
- Preset locked by hooking

Valve performance technical data

2 tubi - pipes - tubes Leiter - tubos			1	2	3	4	5	6	7
	DN		DN 15	DN 20	DN 25	DN 32	DN 32	-	-
Attacchi idraulici - Hydraulic connections Raccords hydrauliques - Hydraulikanschlüsse - Conexiones hidráulicas	ø		3/4"	1"	1"1/4	1"1/2	1"1/2	-	-
Portata acqua valvola - Valve water flow Débit d'eau valve - Wassermenge am Ventil - Caudal de agua de la válvula	l/s	min-max	0,030-0,150	0,062-0,311	0,12-0,6	0,200-1,000	0,200-1,000	-	-
Portata acqua unità - Unit water flow Débit d'eau unité - Wasserdurchfluss des Gerätes - Caudal de agua de la unidad	l/s	min	0,120	0,254	0,279	0,325	0,584	0,651	1,092
		max	0,151	0,312	0,476	0,621	0,794	1,291	1,472

For technical data related to size 6 and 7 please contact the sales department.

4 tubi (scambiatore ausiliario) - pipes (auxiliary coil) tubes (batterie auxiliaire) - Leiter (Zusatzwärmetauscher) - tubos (batería auxiliar)			1	2	3	4	5	6	7
	DN		DN 15	DN 20	DN 25	DN 25	DN 25	DN 32	DN 32
Attacchi idraulici - Hydraulic connections Raccords hydrauliques - Hydraulikanschlüsse - Conexiones hidráulicas	ø		3/4"	1"	1"1/4	1"1/4	1"1/4	1"1/2	1"1/2
Portata acqua valvola - Valve water flow Débit d'eau valve - Wassermenge am Ventil - Caudal de agua de la válvula	l/s	min-max	0,030-0,150	0,062-0,311	0,12-0,6	0,12-0,6	0,12-0,6	0,200-1,000	0,200-1,000
Portata acqua unità - Unit water flow Débit d'eau unité - Wasserdurchfluss des Gerätes - Caudal de agua de la unidad	l/s	min	0,084	0,165	0,183	0,214	0,375	0,433	0,691
		max	0,115	0,218	0,333	0,428	0,551	0,908	0,993

Presetting and nomograms

In accordance with the principles of dynamic balancing, presetting allows you to set the maximum flow rate of the valve, i.e. the flow rate which will be kept constant within the differential pressure range of use, with the valve fully open. The presetting affects the minimum differential pressure of use of the valve.

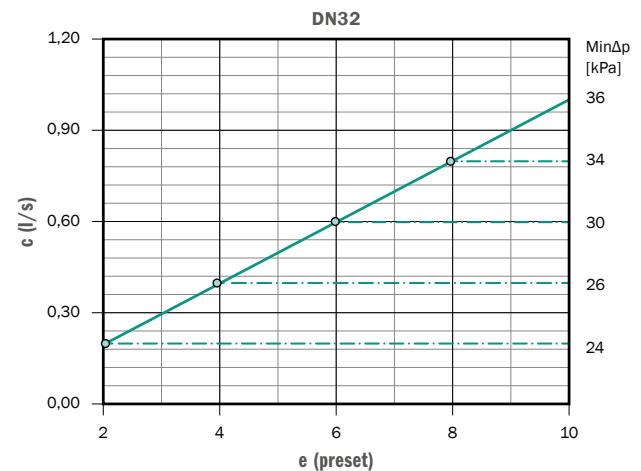
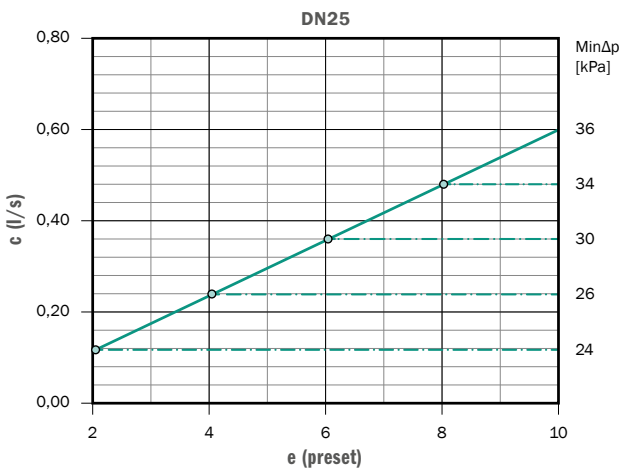
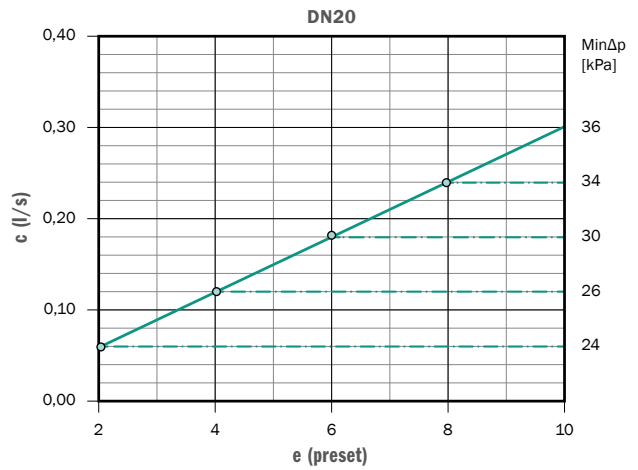
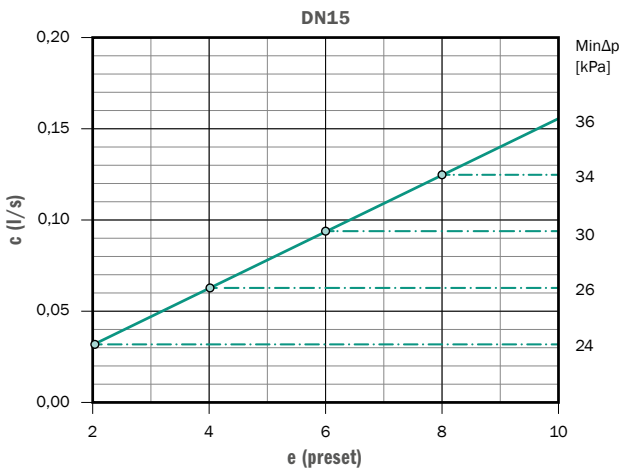
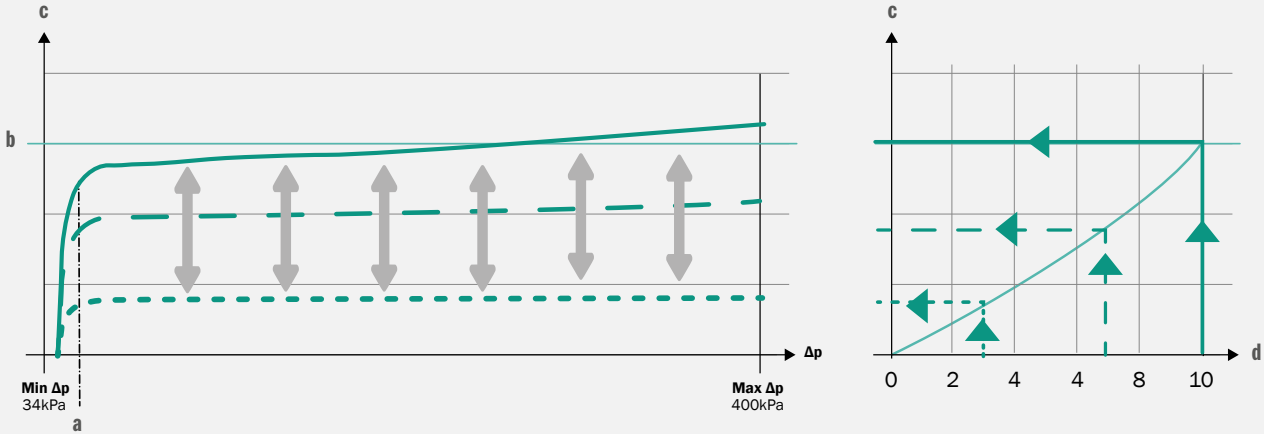

EOS | EOS-ECM

a	Funzione di prerogolazione / Preset function / Fonction de pré-réglage / Voreingestellte Funktion / Función preestablecida
b	Portata prerogolata / Preset flow rate / Débit pré-réglé / Voreingestellte Durchflussmenge / Caudal preestablecido
c (l/s)	Portata / Flow / Débit / Durchflussrate / Caudal
d	Segnale / Signal / Signal / Signal / Señal
e	Prerogolazione / Preset / Pré-réglage / Voreinstellung / Preajuste

The new generation filtration system

Clean Life system

Clean Life System consists of a two-stage filtration module that can be integrated directly into the series, the fact that the solid particles contained in the air flow are precipitated by the action of an electric field that retains the polluting particles and microorganisms dispersed in the air, such as bacteria, viruses and spores conveyed by such particles.

Through a potential difference generated between the emission and collection electrodes, the pollutants are precipitated, captured and retained by special collection grilles, obtaining healthy and completely purified air.

Electronic filter version

Clean Life System - EOS

Available for all 7 models.

Clean Life System ensures that the maximum particulate values, PM10 and PM2.5, remain at acceptable levels in all the internal environments and comply with the requirements of EN 16798:2018 and UNI 11254:2007 to improve **Indoor Air Quality** according to the requisites of the World Health Organization and in accordance with the European and international communities.

This innovative filtering system is managed and controlled through specially developed electronics which, in addition to controlling the operating voltages and the state of efficiency of the filter, gives warning signals of possible malfunctions and failures.

Another fundamental aspect of this system is its cleaning process, which is remarkably simple, economical and easy to implement. The filtering section is fully accessible and optimized to reduce maintenance times and related operating costs.

Once the filter has been removed, the washing cycle needed to regenerate it simply requires water and a biodegradable cleanser. Furthermore, the high-quality components used to build this filtering system guarantee its durability and high reliability over time.

Units equipped with the **Clean Life System** can be installed in diverse environments, from the most sensitive areas, such as medical and healthcare environments requiring total hygiene in the facility, and densely populated areas such as schools, offices, hotels and public places, where it is required to provide occupants with excellent comfort and environmental protection.

A healthy choice, responsible and aware

This innovative solution is characterized not only by its high filtration efficiency (comparable to a mechanical F9 class filter) but also by considering the reduction in energy consumption, provided primarily by a significant decrease in pressure drops, which distinguish this filtration system from any other.

Clean Life System is a considered choice, in reducing the impact on the environment, an impact that cannot be avoided with the use of common mechanical filters. The latter must be disposed of with significant economic costs as they are classified as toxic waste and are bound by restrictions in the disposal processes, which precludes them being returned in the recycling chain.

The electronic filtering system **Clean Life System** is unequivocally ecofriendly because it can be 100% regenerated by simple cleaning, removing the polluting particles that have been collected in the process.

The series can be equipped with a wide range of accessories specifically designed and selected to be able to offer the customer solutions that can respond to every system requirement.

Where provided, the accessories can also be supplied already installed and tested in the company, or supplied separately. For the complete list of available accessories, please refer to the price-list catalog.

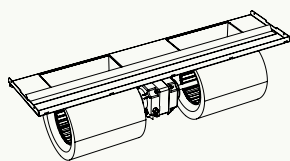

Fan section:

the version can be equipped with special motor with fail contact
On demand also motor with particular specifications.

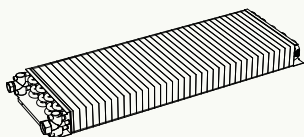

Coils:

6-row coils for 2-pipe systems, or 2 rows for 4-pipe systems, R410A DX coil.
On request also special coils made with special materials or treatments for corrosive atmospheres or with technical precautions to be able to operate at special pressures.

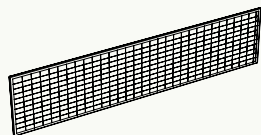

Air filters

a wide range of optional filters are available with greater efficiencies including G3 * / EU3 ** 25 mm, G4 * / EU4 ** 48 mm or filter with aluminum mesh G1 * / EU1 ** 12 mm.

Also available is the innovative electronic filter that allows complete air purification and at the same time ensures high efficiency thanks to minimal pressure drops.

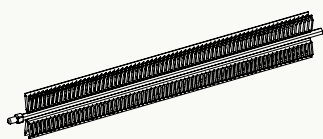

Section with electric heaters:

electric heater kit from 4500W a 19200W, equipped with safety thermostat, 400Vac/3Ph+N/50-60Hz.

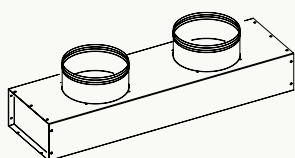

Plenum:

wide range of plenums, ducts, return / supply vents and flexible connection for every installation requirement.

Fully customized plenums can also be made on request.

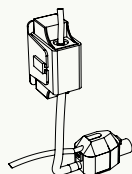

Auxiliary condensate drain pump

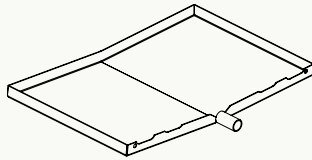

Auxiliary drain pan
hot painted galvanized steel

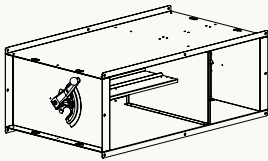

Air lower section
(primary air, max 33%), can also be equipped with servomotor for motorized opening.

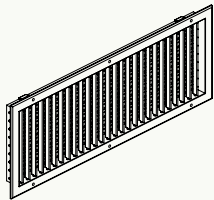

Grills:
supply or intake grills adjustable or fixed type made of anodized aluminium, also in the version already complete with integrated filter.
The grills can also be painted on request with the RAL color of your choice.

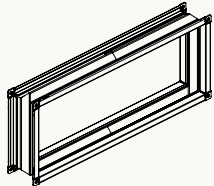

Antivibrating joint

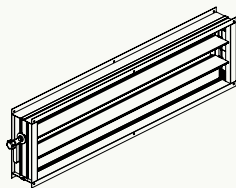

Aluminium damper



Control:
wide range of control devices and related accessories that allow you to manage the correct room temperature. Multiple solutions available based on the installation type, the required performances and the type of investment.

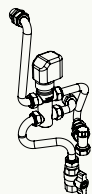

Valves:
wide range of valves, on / off, modulating, floating, two and three ways, which can be supplied already installed and tested or supplied pre-assembled but loose. Also available are the innovative dynamic balancing valves that guarantee effective flow stabilization by controlling the differential pressure, ensuring a constant flow capable of reducing operating costs and higher system efficiency.

Example of ducting accessories application

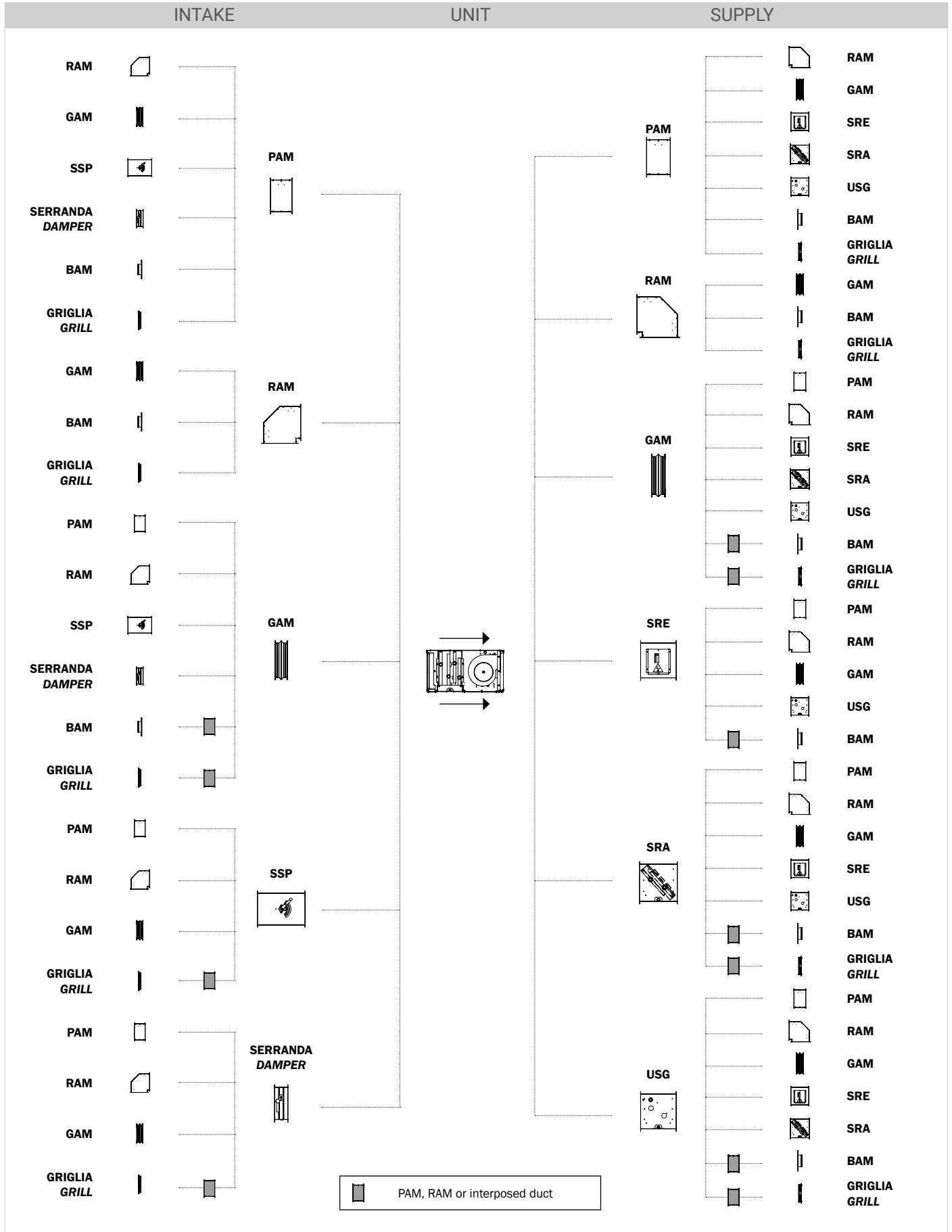

Example of ducting accessories application

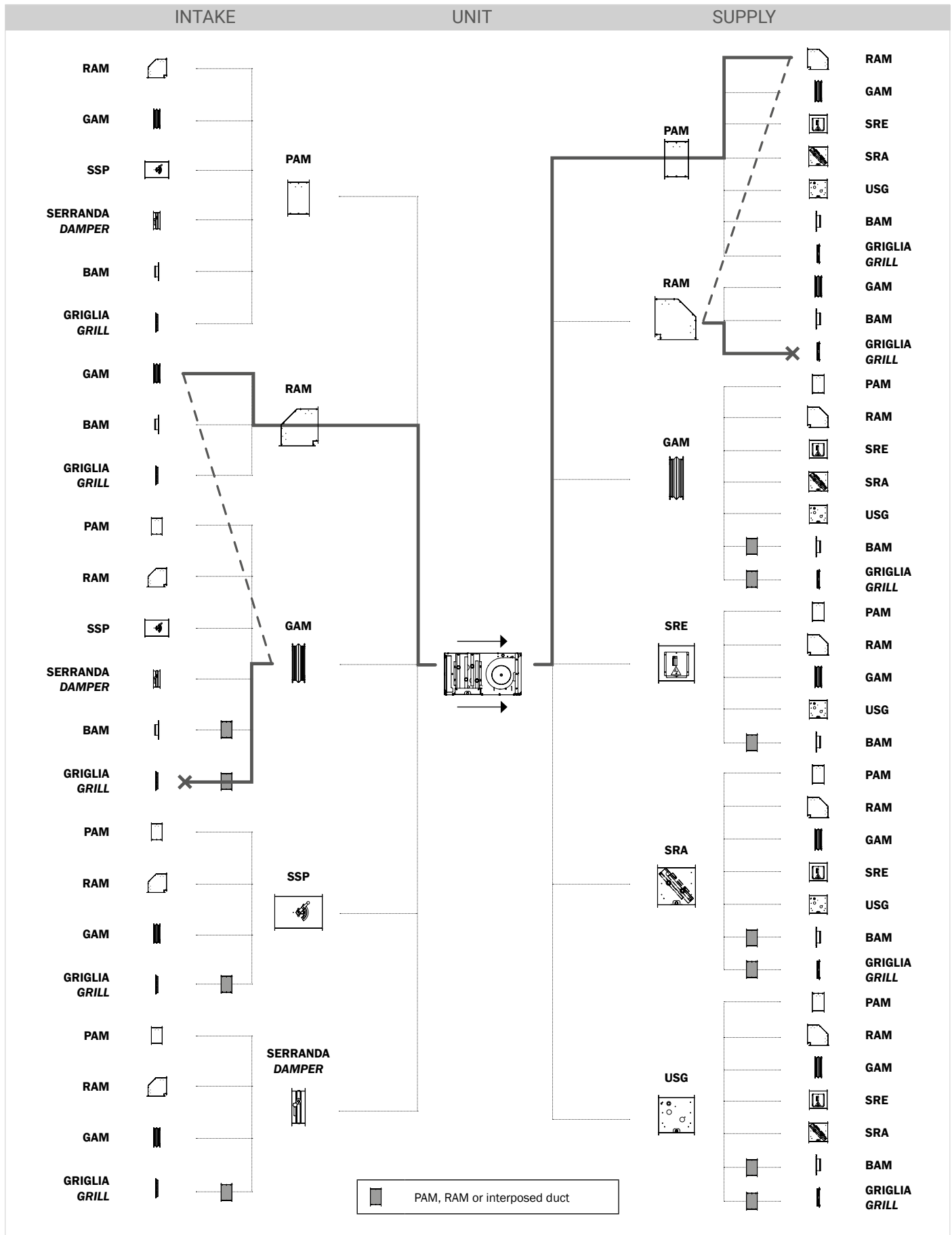

EOS | EOS-ECM

Compatibility of controls

For the complete specifications of the controls, please refer to the part relating to the controls, available from page 298.

503FA	<ul style="list-style-type: none"> - Termostato elettronico con display LCD - Electronic thermostat with LCD display - Thermostat électronique avec écran LCD - Elektronisches Thermostat mit LCD-Display - Termostato electrónico con pantalla LCD 	i-Basic 3	<ul style="list-style-type: none"> - Termostato elettronico analogico con programmazione semplificata a DIP-SWITCH - Analog electronic thermostat with simplified DIP-SWITCH programming - Thermostat électronique analogique avec programmation simplifiée à DIP-SWITCH - Analoger elektronischer Thermostat mit vereinfachter DIP-Schalter Programmierung - Termostato electrónico analógico con programación simplificada DIP-SWITCH
CD11	<ul style="list-style-type: none"> - Comando senza regolazione di temperatura - Control without temperature control - Commande sans réglage de température - Steuerung ohne Temperaturregelung - Control sin regulación de temperatura 	i-Com	<ul style="list-style-type: none"> - Comando senza regolazione di temperatura - Base switch without temperature control - Commande sans réglage de température - Regler für Geräte für 2-Leiter oder 4-Leiter-System ohne Temperaturregelung - Control sin regulación de temperatura
COM-B	<ul style="list-style-type: none"> - Commutatore 3 velocità con selettore rotativo BTicino - BTicino rotary selector switch - Commutateur 3 vitesses avec sélecteur rotatif BTicino - Umschalter der 3 Geschwindigkeitsstufen mittels Wahlschalter BTicino - Conmutador de 3 velocidades con selector giratorio b-Ticino 	i-Digit 0-1-2-3	<ul style="list-style-type: none"> - Termostato elettronico programmabile con display LCD - Programmable electronic thermostat with LCD display - Thermostat électronique programmable avec écran LCD - Elektronischer Thermostat für Gebläsekonvektoren mit 2-Leiter oder 4-Leiter-System, mit LCD-Display - Termostato electrónico programable con pantalla LCD
COM-V	<ul style="list-style-type: none"> - Commutatore 3 velocità con selettore a slitta Vimar - Vimar 3-speed slide selector - Commutateur 3 vitesses avec sélecteur à glissière Vimar - Umschalter der 3 Geschwindigkeitsstufen mittels Schiebeselector Vimar - Conmutador de 3 velocidades con selector deslizante Vimar 	IR-C	<ul style="list-style-type: none"> - Telecomando a raggi infrarossi (per cassette e sistemi TRI/F1 2.0 + S-MOD) - Infrared remote control (for cassette and TRI/F1 2.0 + S-MOD systems) - Télécommande à infrarouges (pour cassette et TRI/F1 2.0 + S-MOD systèmes) - Infrarot-Fernbedienung (für Kassettengeräte und TRI/F1 2.0 + S-MOD Systeme) - Control remoto IR (para fancoil de tipo cassette e sistemas TRI/F1 2.0 + S-MOD)
FAN01	<ul style="list-style-type: none"> - Regolatore per fan coil configurabile con protocollo di comunicazione BACnet - Configurable fan coil controller with BACnet communication protocol - Régulateur pour ventilconvecteur configurable avec protocole de communication BACnet - Regler für Gebläsekonvektor konfigurierbar über Kommunikationsprotokoll BACnet - Controlador fancoil configurable con protocolo de comunicación BACnet 	IR-T	<ul style="list-style-type: none"> - Telecomando a raggi infrarossi (per unità a parete) - Infrared remote control (for wall unit) - Télécommande à infrarouges (pour unité murale) - Infrarot-Fernbedienung für wandmontierte Geräte - Control remoto IR (para unidad de pared)
i-10	<ul style="list-style-type: none"> - Termostato elettronico analogico base (unità a 2 e 4 tubi) - Analog electronic thermostat (2 and 4 pipe units) - Thermostat électronique analogique base (unité à 2 et 4 tubes) - Analoger elektronischer Basisthermostat für Geräte mit 2-Leiter- oder 4-Leiter-System - Termostato electrónico analógico base (unidades de 2 y 4 tubos) 	QCB	<ul style="list-style-type: none"> - Quadro comando base - Base control panel - Panneau de contrôle base - Basisbediengerät - Panel de control base
i-20	<ul style="list-style-type: none"> - Termostato elettronico analogico (unità a 2 tubi) - Analog electronic thermostat (2 pipe units) - Thermostat électronique analogique (unité à 2 tubes) - Analoger elektronischer Thermostat für Geräte mit 2-Leiter-System - Termostato electrónico analógico (unidad de 2 tubos) 	QCL	<ul style="list-style-type: none"> - Quadro comando base in lamiera - Sheet base control panel - Panneau de contrôle base en tôle - Basisbediengerät aus Metall - Panel de control base en chapa
i-25	<ul style="list-style-type: none"> - Termostato elettronico analogico (unità a 4 tubi) - Analog electronic thermostat (4 pipe units) - Thermostat électronique analogique (unité à 4 tubes) - Analoger elektronischer Thermostat für Geräte mit 4-Leiter-System - Termostato electrónico analógico (unidad de 4 tubos) 	QEL	<ul style="list-style-type: none"> - Quadro comando base in lamiera - Sheet base control panel - Panneau de contrôle base en tôle - Basisbediengerät aus Metall - Panel de control base en chapa
i-30	<ul style="list-style-type: none"> - Termostato elettronico programmabile con display LCD - Programmable electronic thermostat with LCD display - Thermostat électronique programmable avec écran LCD - Programmierbarer elektronischer Thermostat für Gebläsekonvektoren mit 2/4-Leiter-System, mit LCD-Display - Termostato electrónico programable con pantalla LCD 	QTE	<ul style="list-style-type: none"> - Quadro comando base con termostato ambiente elettronico - Base control panel with electronic room thermostat - Panneau de contrôle base avec thermostat ambient électronique - Basisbediengerät mit elektronischem Raumthermostat - Panel de control base con termostato ambiente electrónico
i-50	<ul style="list-style-type: none"> - Termostato elettronico programmabile con display LCD - Programmable electronic thermostat with LCD display - Thermostat électronique programmable avec écran LCD - Programmierbarer elektronischer Thermostat für Gebläsekonvektoren mit 2/4-Leiter-System, mit LCD-Display - Termostato electrónico programable con pantalla LCD 	QTM	<ul style="list-style-type: none"> - Quadro comando base con termostato ambiente elettromeccanico (a bulbo) - Base control panel with room electromechanical temperature bulb thermostat - Panneau de contrôle base avec thermostat ambient électromécanique (à bulbe) - Basischalttafel mit elektromechanischem Raumtempertur-Thermostat (mit Stabfühler) - Panel de control base con termostato ambiente electromecánico (a bulbo)
i-60	<ul style="list-style-type: none"> - Termostato elettronico touch con connessione WiFi per gestione remota - Touch fan coil thermostat with WiFi connection - Thermostat électronique tactile avec connexion WiFi pour gestion à distance - Elektronischer Touch-Thermostat mit WiFi-Anbindung für Fernüberwachung - Termostato electrónico Touch con conexión WiFi para gestión remota 	RWIECM 1-2	<ul style="list-style-type: none"> - Interfaccia utente a parete - Wall user interface - Interface utilisateur mural - Wandmontiertes Bediengerät - Interfaz de usuario de pared
i-70	<ul style="list-style-type: none"> - Termostato elettronico touch configurabile, con protocollo di comunicazione MODbus/BACnet (unità a 2 e 4 tubi) - Touch programmable electronic thermostat with MODbus/BACnet protocol communication (unit 2 and 4 pipe system) - Thermostat électronique tactile configurable, avec protocole de communication MODbus/BACnet (unité à 2 et 4 tubes) - Konfigurierbarer elektronischer Touch-Thermostat, mit MODbus/BACnet-Kommunikation mit 2/4-Leiter-System - Termostato electrónico Touch configurable, con protocolo de comunicación Modbus / Bacnet (unidades de 2 y 4 tubos) 	S-MOD	<ul style="list-style-type: none"> - Sistema di supervisione - Supervision system - Système de supervision - Überwachungssystem - Sistema de supervisión
i-Basic 1	<ul style="list-style-type: none"> - Termostato elettronico analogico base - Analog base electronic thermostat - Thermostat électronique analogique base - Analoger elektronischer Basisthermostat für Geräte mit 2-Leiter oder 4-Leiter-System - Termostato electrónico analógico base 	TRI/F1 2.0	<ul style="list-style-type: none"> - Controllo con telecomando IR o interfaccia a muro con protocollo di comunicazione MODbus - Infrared remote controller or wall controller with MODbus communication protocol - Contrôle avec télécommande IR ou interface mural avec protocole de communication MODbus - Steuerung mittels Infrarot-Fernbedienung oder wandmontiertes Bedienfeld mit MODbus-Kommunikationsprotokoll - Control con mando IR o interfaz de pared con protocolo de comunicación MODbus
i-Basic 2	<ul style="list-style-type: none"> - Termostato elettronico analogico - Analog electronic thermostat - Thermostat électronique analogique - Analoger elektronischer Thermostat für Geräte mit 2-Leiter oder 4-Leiter-System - Termostato electrónico analógico 		

Compatibility of controls

Scheda di potenza per controllo a 3 velocità
 Power chart for 3-speed control
 Fiche de puissance pour contrôle à 3 vitesses
 Leistungsplatine zur Steuerung mit 3 Geschwindigkeiten
 Tarjeta de alimentación para el control de 3 velocidades

	i-Com	i-Basic 1	i-Basic 2	i-Basic 3	i-Digit 0-1-2-3	TRI/F1 2.0	CD11	i-10	i-20	i-25	i-30	i-50	i-60	i-70	503FA	503BUS+DIN5	S-MOD	FAN01
Mod. 1	-	-	○	○	○	-	-	-	-	-	○	○	○	○	○	-	○	○
Mod. 2	-	-	○	○	○	-	-	-	-	-	○	○	○	○	○	-	○	○
Mod. 3	-	○	○	○	○	-	-	-	-	-	○	○	○	○	○	-	○	○
Mod. 4	●	●	●	●	●	●	●	●	●	●	●	●	●	●	●	-	●	●
Mod. 5	●	●	●	●	●	●	●	●	●	●	●	●	●	●	●	-	●	●
Mod. 6	●	●	●	●	●	●	●	●	●	●	●	●	●	●	●	-	●	●
Mod. 7	●	●	●	●	●	●	●	●	●	●	●	●	●	●	●	-	●	●

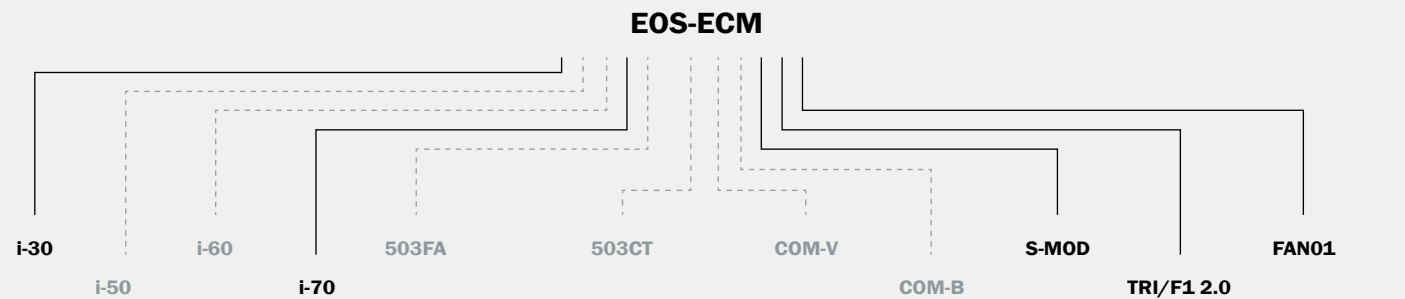
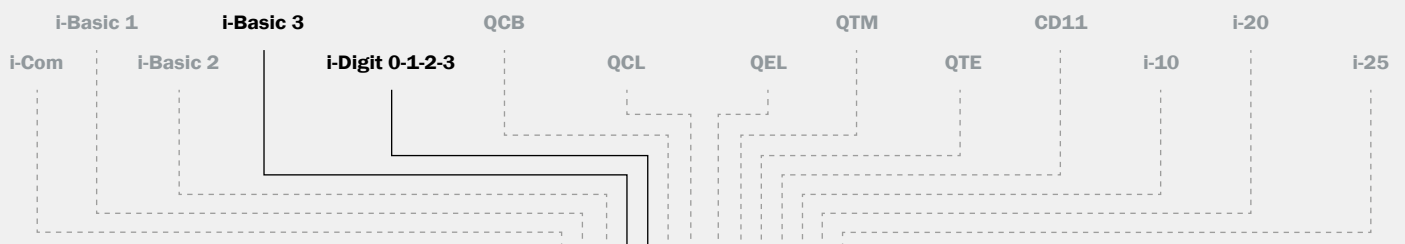
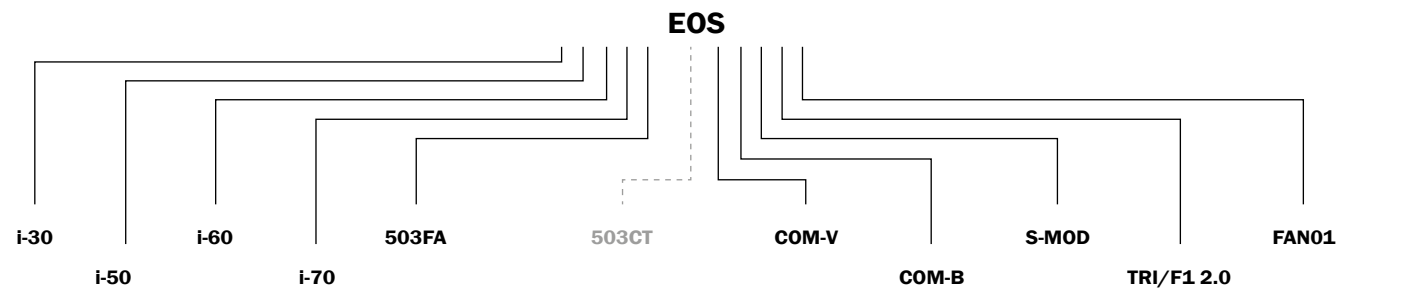
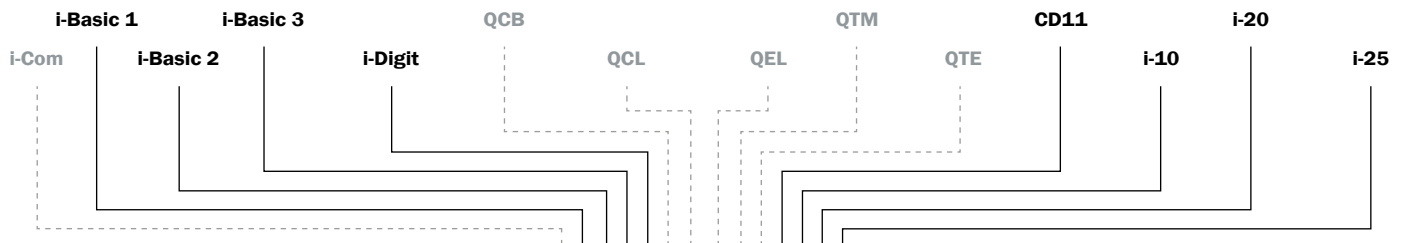

- Compatible
Compatible
Compatible
Kompatibel
Compatible
- - - Non compatibile
Not compatible
Non compatible
Nicht kompatibel
NO compatible
- Non necessaria
Not necessary
Non nécessaire
Nicht erforderlich
No Requerido
- Necessaria (inclusa di serie)
Necessary (included as standard)
Nécessaire (comprise de série)
Erforderlich (serienmäßig inbegriffen)
Requerido (incluido de serie)
- Necessaria (non inclusa)
Necessary (not included)
Nécessaire (non comprise)
Erforderlich (nicht inbegriffen)
Requerido (no incluido)

EOS | EOS-ECM

COMPATIBILITÀ - COMPATIBILITY - COMPATIBILITÉ - KOMPATIBILITÄT - COMPATIBILIDAD

Installazione a parete da esterno - Wall mounting - Installation murale - Wandmontage - Instalación a pared

Installazione a bordo unità - On board unit installation - Installation embarquée - Installation auf dem Gerät - Instalación al bordo de la unidad

Installazione a parete da incasso - Wall flush-mounting - Installation à encaissement - Wandeinbau - Instalación empotrada

REGOLATORI - CONTROLLERS - RÉGULATEURS - REGLER - REGULADORES

UTILIZZO - USE - UTILISATION - VERWENDUNG - USO

Impianto a 2 tubi - 2 pipe system - Système à 2 tubes - Anlage mit 2 Leiter-System - Sistema de 2 tubos

Impianto a 4 tubi - 4 pipe system - Système à 4 tubes - Anlage mit 4 Leiter-System - Sistema de 4 tubos

CONTROLLI E DISPLAY - CONTROLS & DISPLAY - CONTRÔLES ET ÉCRAN - STEUERUNGEN UND DISPLAY - CONTROLES Y PANTALLAS

Display - Display - Écran - Display - Monitor

Acceso/Spento - On/Off - Allumé/Éteint - Eingeschaltet/Ausgeschaltet - Encendido /Apagado

Caldo/Freddo - Heat/Cool - Chaud/Froid - Heizen/Kühlen - Frío /Caliente

3 velocità ventilatore - 3 fan speed - 3 vitesses ventilateur - 3 Gebläsegeschwindigkeiten - 3 velocidades de ventilador

Regolazione temperatura - Set point range - Réglage température - Temperaturregelung - Regulación de la temperatura

COMMUTAZIONE - CHANGEOVER - COMMUTATION - UMSCHALTUNG - TRASPUESTA

Velocità automatica - Automatic speed control - Vitesse automatique - Automatische Geschwindigkeitseinstellung - Velocidad automática

Caldo/freddo centralizzata - Central season changeover - Chaud/froid centralisé - Heizen/Kühlen Umschaltung - Cambio Verano / Invierno centralizado

Caldo/freddo automatico (impianto 2 tubi) - Automatic season changeover (2 pipe system) - Chaud/froid automatique (système à 2 tubes) Heizen/Kühlen Umschaltung automatisch (Anlage mit 2 Leitersystem) - Cambio automático Verano / Invierno (sistema de 2 tubos)

Caldo/freddo automatico con zona neutra (imp. 4 tubi) - Automatic season changeover with neutral zone (4 pipe syst.) - Chaud/froid automatique avec zone neutre (syst. à 4 tubes) - Heizen/Kühlen Umschaltung automatisch mit neutralem Bereich (Anlage mit 4 Leiter-System) - Cambio automático Verano/Invierno con zona neutra (sist. de 4 tubos)

INGRESSI - INPUTS - ENTRÉES - EINGÄNGE - ENTRADAS

Sonda aria remota - Remote air intake sensor - Capteur air à distance - Lufteintrittsfühler - Sonda de aire remota

Sonda acqua - Water sensor - Capteur eau - Wassertemperaturfühler - Sonda de agua

[TC/TC-B] Termostato di consenso - Low temperature thermostat - Thermostat d'autorisation - Freigabethermostat - Termostato de mínima

Contatto finestra - Windows contact - Contact fenêtre - Fensterkontakt - Contacto de ventana

USCITE - OUTPUTS - SORTIES - AUSGÄNGE - SALIDAS

Valvole On/Off - On/Off valves - Vannes On/Off - Ein-Aus-Ventil - Válvulas On/Off

Valvole 3 punti (PWM) - Floating valves (PWM) - Vannes 3 points (PWM) - 3-Punkt-Ventil (PWM) - Válvulas de 3 puntos (PWM)

Valvole 0-10V - 0-10V proportional valves - Vannes 0-10V - Ventile 0-10 V - Válvulas 0-10V

FUNZIONI SPECIALI - SPECIAL FUNCTIONS - FONCTION SPÉCIALES - SONDERFUNKTIONEN - FUNCIONES ESPECIALES

Ventilatore termostato - Fan thermostat controlled - Ventilateur thermostaté - Thermostatgesteuerter Ventilator - Ventilador termostático

Comando resistenza elettrica - Electric heater control - Commande résistance électrique - Steuerung Elektroheizregister - Control de resistencia eléctrica

Funzione economy - Economy function - Fonction economy - Economy-Funktion - Función Economy

Funzione solo ventilazione - Fan function - Fonction uniquement ventilation - Nur Ventilatorbetrieb - Función sólo ventilador

Timer giornaliero - Daily timer - Minuterie quotidienne - Tagestimer - Temporizador diario

Funzione antistratificazione - Air recirculation function - Fonction anti-stratification - Funktion zum Schutz gegen Schichtbildung - Función anti-estratificación

Funzione Master/Slave - Master/Slave function - Fonction Master/Slave - Master/Slave Funktion - Función Master/Slave

Ventilatore modulante - Modulating fan - Ventilateur modulant - Modulierender Ventilator - Ventilador modulante

Programmazione settimanale - Weekly timetable - Programmation hebdomadaire - Wochenprogrammierung - Programación semanal

[MODbus] Protocollo di comunicazione - Communication protocol - Protocole de communication - Kommunikationsprotokoll - Protocolo de comunicación

[BACnet] Protocollo di comunicazione - Communication protocol - Protocole de communication - Kommunikationsprotokoll - Protocolo de comunicación

Controllo umidità - Humidity control - Contrôle de l'humidité - Feuchtigkeitsregelung - Control humedad

The diagrams, the descriptions and the pictures shown herein are merely indicative and in no way binding. In order to continuously improve and in view of constant research and development, A GROUP S.p.A. reserves the right to modify, also without prior notice, technical data and all the contents included in this document.

Concept and design: Aliseo Group

04/2021



A GROUP S.p.A.

Via Monte Grappa, 67
31020 San Zenone degli Ezzelini (TV) - Italy
Tel. +39 0423 567774 - Fax +39 0423 567985
info@eden-clima.com - www.eden-clima.com
www.aliseogroup.com



Check ongoing validity of certificate:
www.eurovent-certification.com